



DSE Genset[®]



DEEP SEA ELECTRONICS PLC

DSE7450 Operator Manual

Document Number: 057-170

Author: Ashley Senior

DEEP SEA ELECTRONICS PLC

Highfield House
 Hunmanby
 North Yorkshire
 YO14 0PH
 ENGLAND



Sales Tel: +44 (0) 1723 890099
 Sales Fax: +44 (0) 1723 893303

E-mail : sales@deepseapl.com
 Website : www.deepseapl.com

DSE7450 Operator Manual

© Deep Sea Electronics Plc

All rights reserved. No part of this publication may be reproduced in any material form (including photocopying or storing in any medium by electronic means or other) without the written permission of the copyright holder except in accordance with the provisions of the Copyright, Designs and Patents Act 1988.

Applications for the copyright holder's written permission to reproduce any part of this publication should be addressed to Deep Sea Electronics Plc at the address above.

The DSE logo is a UK registered trademarks of Deep Sea Electronics PLC.

Any reference to trademarked product names used within this publication is owned by their respective companies.

Deep Sea Electronics Plc reserves the right to change the contents of this document without prior notice.

Amendments List

Issue	Comments	Minimum Module Version Required
1	Initial release	V1.0.0
2	Added AVR terminal information, added display new screens, updates to FPE and running editor	V2.0.0
3	Removed unneeded notes regarding: low plant battery voltage level alarm, and mains failure detection in case of external rectifier.	V2.0.0

Typeface: The typeface used in this document is *Arial*. Care should be taken not to mistake the upper case letter I with the numeral 1. The numeral 1 has a top serif to avoid this confusion.

Clarification of notation used within this publication.



	NOTE	Highlights an essential element of a procedure to ensure correctness.
	CAUTION!	Indicates a procedure or practice, which, if not strictly observed, could result in damage or destruction of equipment.
	WARNING!	Indicates a procedure or practice, which could result in injury to personnel or loss of life if not followed correctly.

TABLE OF CONTENTS

Section	Page
1 BIBLIOGRAPHY	7
1.1 INSTALLATION INSTRUCTIONS.....	7
1.2 TRAINING GUIDES	7
1.3 MANUALS	7
1.4 THIRD PARTY DOCUMENTS.....	7
2 INTRODUCTION	8
3 SPECIFICATIONS.....	9
3.1 SHORT NAMES.....	9
3.2 TERMINAL SPECIFICATION.....	9
3.3 POWER SUPPLY REQUIREMENTS	9
3.3.1 MODULE SUPPLY INSTRUMENTATION DISPLAY.....	9
3.4 GENERATOR AND MAINS VOLTAGE /FREQUENCY SENSING	10
3.5 DC PLANT SUPPLY VOLTAGE SENSING	10
3.6 DC SHUNT 1 & 2 CURRENT SENSING	10
3.6.1 SHUNT CONNECTION	11
3.6.2 SHUNT ACCURACY	11
3.7 INPUTS.....	12
3.7.1 DIGITAL INPUTS.....	12
3.7.2 ANALOGUE INPUTS.....	12
3.7.2.1 OIL PRESSURE	12
3.7.2.2 COOLANT TEMPERATURE	12
3.7.2.3 FUEL LEVEL	13
3.7.2.4 BATTERY TEMPERATURE.....	13
3.7.2.5 FLEXIBLE SENSOR (THROUGH CONFIGURATION).....	13
3.7.3 CHARGE FAIL INPUT	14
3.7.4 MAGNETIC PICKUP.....	14
3.7.5 OUTPUTS.....	15
3.7.5.1 OUTPUTS A & B	15
3.7.5.2 CONFIGURABLE OUTPUTS C & D (LOAD SWITCHING)	15
3.7.5.3 OUTPUTS E,F,G,H, I & J	15
3.7.5.4 AVR BIAS OUTPUT	15
3.8 COMMUNICATION PORTS	16
3.9 COMMUNICATION PORT USAGE.....	16
3.9.1 CAN INTERFACE.....	16
3.9.2 USB CONNECTION	17
3.9.3 USB HOST-MASTER (USB DRIVE CONNECTION)	17
3.9.4 RS232	18
3.9.4.1 RECOMMENDED PC RS232 SERIAL PORT ADD-ONS	18
3.9.4.2 RECOMMENDED EXTERNAL MODEMS:	19
3.9.5 RS485	20
3.9.5.1 RECOMMENDED PC RS485 SERIAL PORT ADD-ONS	20
3.9.6 ETHERNET.....	21
3.9.6.1 DIRECT PC CONNECTION	22
3.9.6.2 CONNECTION TO BASIC ETHERNET	23
3.9.6.3 CONNECTION TO COMPANY INFRASTRUCTURE ETHERNET.....	24
3.9.6.4 CONNECTION TO THE INTERNET	25
3.9.6.5 FIREWALL CONFIGURATION FOR INTERNET ACCESS.....	26
3.10 DSENET® FOR EXPANSION MODULES.....	27
3.10.1 DSENET® USED FOR MODBUS ENGINE CONNECTION	27
3.11 SOUNDER.....	28
3.11.1 ADDING AN EXTERNAL SOUNDER TO THE APPLICATION.....	28
3.12 ACCUMULATED INSTRUMENTATION.....	28
3.13 DIMENSIONS AND MOUNTING	29

3.13.1	DIMENSIONS	29
3.13.2	PANEL CUTOUT	29
3.13.3	WEIGHT	29
3.13.4	FIXING CLIPS.....	30
3.13.5	CABLE TIE FIXING POINTS	31
3.13.6	SILICON SEALING GASKET	31
3.13.7	APPLICABLE STANDARDS.....	32
3.13.8	ENCLOSURE CLASSIFICATIONS.....	34
3.13.8.1	IP CLASSIFICATIONS	34
3.13.8.2	NEMA CLASSIFICATIONS	35
4	INSTALLATION	36
4.1	TERMINAL DESCRIPTION	36
4.1.1	DC SUPPLY, FUEL AND START OUTPUTS, OUTPUTS E-J	37
4.1.2	ANALOGUE SENSOR.....	38
4.1.3	MAGNETIC PICKUP, CAN AND EXPANSION	39
4.1.4	LOAD SWITCHING AND V1 GENERATOR AC VOLTAGE SENSING	40
4.1.5	MAINS AC VOLTAGE SENSING	40
4.1.6	GENERATOR DC VOLTAGE & CURRENT SENSING.....	41
4.1.6.1	SHUNT CONNECTIONS.....	41
4.1.7	CONFIGURABLE DIGITAL INPUTS	42
4.1.8	PC CONFIGURATION INTERFACE CONNECTOR	42
4.1.9	RS232 CONNECTOR.....	43
4.1.10	RS485 CONNECTOR.....	43
4.2	TYPICAL WIRING DIAGRAM	44
4.3	TYPICAL SINGLE LINE DIAGRAMS.....	45
4.3.1	WITH MAINS SENSING	45
4.3.1.1	AC GENERATOR AND RECTIFIER WITH A COMMON DC BUS.....	45
4.3.1.2	AC GENERATOR AND RECTIFIER WITH A COMMON AC & DC BUS	46
4.3.1.3	DC GENERATOR WITH A COMMON DC BUS	47
4.3.2	WITHOUT MAINS SENSING	48
4.3.2.1	AC GENERATOR WITH EXTERNAL RECTIFIER	48
4.3.2.2	DC GENERATOR.....	49
4.4	EARTH SYSTEMS.....	50
4.4.1	NEGATIVE EARTH.....	50
4.4.2	POSITIVE EARTH	50
4.4.3	FLOATING EARTH.....	50
4.5	TYPICAL ARRANGEMENT OF DSENET®.....	50
5	DESCRIPTION OF CONTROLS.....	51
5.1	QUICKSTART GUIDE	52
5.1.1	STARTING THE ENGINE.....	52
5.1.2	STOPPING THE ENGINE	52
5.2	VIEWING THE INSTRUMENT PAGES	53
5.2.1	STATUS.....	54
5.2.2	ENGINE	55
5.2.3	GENERATOR	56
5.2.4	MAINS.....	56
5.2.5	DC.....	56
5.2.6	PLANT BATTERY.....	56
5.2.7	EVENT LOG	57
5.2.8	ALARMS	58
5.2.8.1	CAN ERROR MESSAGES	58
5.2.9	SERIAL PORT	59
5.2.9.1	RS232 SERIAL PORT	59
5.2.9.2	RS485 SERIAL PORT	63
5.2.10	ABOUT.....	64
5.2.10.1	MODULE INFORMATION	64
5.2.10.2	ETHERNET PAGES	65
5.2.10.3	DATA LOGGING PAGES.....	66
5.3	USER CONFIGURABLE INDICATORS.....	67

6	OPERATION	68
6.1	CONTROL	68
6.2	CONTROL PUSH-BUTTONS.....	69
6.3	STOP MODE.....	71
6.3.1	ECU OVERRIDE.....	72
6.4	MANUAL MODE.....	73
6.4.1	WAITING IN MANUAL MODE.....	73
6.4.2	STARTING SEQUENCE.....	73
6.4.3	ENGINE RUNNING	74
6.4.4	MANUAL FUEL PUMP CONTROL.....	74
6.4.5	STOPPING SEQUENCE	74
6.5	TEST MODE	75
6.5.1	WAITING IN TEST MODE.....	75
6.5.2	STARTING SEQUENCE.....	75
6.5.3	ENGINE RUNNING	76
6.6	AUTOMATIC MODE.....	77
6.6.1	WAITING IN AUTO MODE.....	77
6.6.2	STARTING SEQUENCE.....	77
6.6.3	ENGINE RUNNING	78
6.6.4	STOPPING SEQUENCE	78
6.7	PLANT BATTERY CHARGING SCHEME	79
6.7.1	START REQUEST.....	79
6.7.2	PLANT BATTERY CHARGE STATE.....	79
6.7.3	CALCULATING EFFECTIVE BATTERY CAPACITY	80
6.7.4	CHARGE CYCLE.....	80
6.7.5	DETERMINING THE CHARGE MODE	81
6.7.5.1	TWO STAGE CHARGER.....	81
6.7.5.2	THREE STAGE CHARGER	82
6.7.5.3	FOUR STAGE CHARGER	83
7	PROTECTIONS.....	84
7.1	CAN ERROR MESSAGES	84
7.2	PROTECTIONS DISABLED.....	85
7.2.1	INDICATION / WARNING ALARMS.....	85
7.2.2	SHUTDOWN / ELECTRICAL TRIP ALARMS	85
7.3	INDICATIONS.....	86
7.4	WARNINGS	87
7.5	ELECTRICAL TRIPS.....	90
7.6	SHUTDOWNS.....	92
7.7	DC OVERCURRENT WARNING/ ELECTRICAL TRIP/SHUTDOWN ALARM	95
7.7.1	IMMEDIATE WARNING	95
7.7.2	IDMT ALARM.....	95
7.8	DC SHORT CIRCUIT ALARM.....	98
7.9	MAINTENANCE ALARM	99
8	SCHEDULER	100
8.1.1	STOP MODE	100
8.1.2	MANUAL MODE	100
8.1.3	AUTO MODE	100
8.1.4	TEST MODE.....	100
9	FRONT PANEL CONFIGURATION	101
9.1	ACCESSING THE MAIN FRONT PANEL CONFIGURATION EDITOR.....	102
9.1.1	EDITING A PARAMETER.....	103
9.2	ADJUSTABLE PARAMETERS	104
9.3	ACCESSING THE 'RUNNING' CONFIGURATION EDITOR.....	107
9.3.1	EDITING A PARAMETER.....	107
9.3.2	ADJUSTABLE PARAMETERS (RUNNING EDITOR).....	107
10	COMMISSIONING.....	108

11	FAULT FINDING	109
11.1	STARTING	109
11.2	LOADING	109
11.3	ALARMS	110
11.4	COMMUNICATIONS.....	111
11.5	INSTRUMENTS	112
11.6	MISCELLANEOUS	112
12	MAINTENANCE, SPARES, REPAIR AND SERVICING	113
12.1	PURCHASING ADDITIONAL CONNECTOR PLUGS FROM DSE.....	113
12.2	PURCHASING ADDITIONAL FIXING CLIPS FROM DSE.....	113
12.3	PURCHASING ADDITIONAL SEALING GASKET FROM DSE	113
12.4	DSENET EXPANSION MODULES.....	114
13	WARRANTY	115
14	DISPOSAL	115
14.1	WEEE (WASTE ELECTRICAL AND ELECTRONIC EQUIPMENT)	115

1 BIBLIOGRAPHY

This document refers to and is referred to by the following DSE publications which can be obtained from the DSE website: www.deepseapl.com

1.1 INSTALLATION INSTRUCTIONS

Installation instructions are supplied with the product in the box and are intended as a 'quick start' guide only.

DSE PART	DESCRIPTION
053-143	DSE7450 Installation Instructions
053-032	DSE2548 LED Expansion Annunciator Installation Instructions
053-033	DSE2130 Input Expansion Installation Instructions
053-034	DSE2157 Output Expansion Installation Instructions
053-125	DSE2131 Ratio-metric Input Expansion Installation Instructions
053-126	DSE2133 RTD/Thermocouple Input Expansion Installation Instructions
053-134	DSE2152 Ratio-metric Output Expansion Installation Instructions

1.2 TRAINING GUIDES

Training Guides are produced to give 'handout' sheets on specific subjects during training sessions

DSE PART	DESCRIPTION
056-022	Breaker Control
056-024	GSM Modem
056-029	Smoke Limiting
056-030	Module PIN Codes

1.3 MANUALS

Product manuals are can be downloaded from the DSE website: www.deepseapl.com

DSE PART	DESCRIPTION
057-004	Electronic Engines and DSE Wiring
057-169	DSE7450 Configuration PC Software Manual
057-082	DSE2130 Input Expansion Manual
057-083	DSE2157 Output Expansion Manual
057-084	DSE2548 Annunciator Expansion Manual
057-139	DSE2131 Ratio-metric Input Expansion Manual
057-140	DSE2133 RTD/Thermocouple Expansion Manual
057-141	DSE2152 Ratio-metric Output Expansion Manual

1.4 THIRD PARTY DOCUMENTS

The following third party documents are also referred to:

REFERENCE	DESCRIPTION
ISBN 1-55937-879-4	IEEE Std C37.2-1996 IEEE Standard Electrical Power System Device Function Numbers and Contact Designations. Institute of Electrical and Electronics Engineers Inc
ISBN 0-7506-1147-2	Diesel generator handbook. L.L.J.Mahon
ISBN 0-9625949-3-8	On-Site Power Generation. EGSA Education Committee.

2 INTRODUCTION

This document details the installation and operation requirements of the DSE7450 DC Generator Controller, part of the **DSEgenset®** range of products.

The manual forms part of the product and should be kept for the entire life of the product. If the product is passed or supplied to another party, ensure that this document is passed to them for reference purposes.

This is not a *controlled document*. You will not be automatically informed of updates. Any future updates of this document will be included on the DSE website at www.deepseapl.com

The DSE7450 is designed to provide differing levels of functionality across a common platform. This allows the generator OEM greater flexibility in the choice of controller to use for a specific application.

The DSE7450 controller has been designed to allow the operator to start and stop the generator, manually or automatically via various means to charge a bank of batteries.

The user also has the facility to view the system operating parameters via the LCD display.

The DSE7450 controller monitors the engine, indicating the operational status and fault conditions, automatically shutting down the engine and giving a true first up fault condition of an engine failure by a common audible alarm. The LCD display indicates the fault.

The powerful ARM microprocessor contained within the module allows for incorporation of a range of complex features:

- *Text based LCD display (supporting multiple languages).*
- **True RMS Voltage monitoring.**
- *DC voltage, current and power measurement for battery bank monitoring*
- *Communications capability (RS232, RS485 or Ethernet)*
- *Engine parameter monitoring.*
- *Fully configurable inputs for use as alarms or a range of different functions.*
- *Engine ECU interface to **electronic engines**.*

Using a PC and the DSE Configuration Suite software allows alteration of selected operational sequences, timers, alarms and operational sequences. Additionally, the module's integral fascia configuration editor allows adjustment of a subset of this information.

A robust plastic case designed for front panel mounting houses the module. Connections are via locking plug and sockets..

Access to critical operational sequences and timers for use by qualified engineers, can be protected by a security code. Module access can also be protected by PIN code. Selected parameters can be changed from the module's front panel.

The module is housed in a robust plastic case suitable for panel mounting. Connections to the module are via locking plug and sockets.

3 SPECIFICATIONS

3.1 SHORT NAMES

Short Name	Description
DSE7000,DSE7xxx	All modules in the DSE7000 range.
DSE7400,DSE74xx	All modules in the DSE7400 range.
DSE7450	DSE7450 module/controller

3.2 TERMINAL SPECIFICATION

NOTE: For purchasing additional connector plugs from DSE, please see the section entitled **Maintenance, Spares, Repair and Servicing elsewhere in this document.**

Connection type	Two part connector. <ul style="list-style-type: none"> • Male part fitted to module • Female part supplied in module packing case - Screw terminal, rising clamp, no internal spring. 	 <p>Example showing cable entry and screw terminals of a 10 way connector</p>
Minimum cable size	0.5mm ² (AWG 24)	
Maximum cable size	2.5mm ² (AWG 10)	

3.3 POWER SUPPLY REQUIREMENTS

Minimum supply voltage	8V continuous
Cranking dropouts	Able to survive 0V for 50mS providing the supply was at least 10V before the dropout and recovers to 5V afterwards.
Maximum supply voltage	35V continuous (60V protection)
Reverse polarity protection	-35V continuous
Maximum operating current	300mA at 24V 600mA at 12V
Maximum standby current	190mA at 24V 390mA at 12V

3.3.1 MODULE SUPPLY INSTRUMENTATION DISPLAY

Range	0V-70V DC (note Maximum continuous operating voltage of 35V DC)
Resolution	0.1V
Accuracy	1% full scale ($\pm 0.7V$)

3.4 GENERATOR AND MAINS VOLTAGE /FREQUENCY SENSING

Measurement type	True RMS conversion
Sample Rate	5kHz or better
Harmonics	Up to 15 th or better
Input Impedance	300k Ω ph-N
Phase to Neutral	10V (minimum required for sensing frequency) to 120V AC (absolute maximum) Suitable for 100V nominal ($\pm 20\%$ for under/overvoltage detection)
Phase to Phase	20V (minimum required for sensing frequency) to 208V AC (absolute maximum) Suitable for 173V ph-ph nominal ($\pm 20\%$ for under/overvoltage detection)
Common mode offset from Earth	100V AC (max)
Resolution	1V AC phase to neutral 2V AC phase to phase
Accuracy	$\pm 1\%$ of full scale phase to neutral $\pm 2\%$ of full scale phase to phase
Minimum frequency	3.5Hz
Maximum frequency	75.0Hz
Frequency resolution	0.1Hz
Frequency accuracy	± 0.05 Hz

3.5 DC PLANT SUPPLY VOLTAGE SENSING

Measurement type	True RMS measurement to allow for DC ripple
Sample Rate	5kHz or better
Input Impedance	300k Ω +ve to -ve
Voltage Range	5V to 75V DC (absolute maximum)
Common mode offset from Earth	± 75 V DC (absolute maximum)
Resolution	1V DC
Accuracy	$\pm 1\%$ of full scale -ve to +ve

3.6 DC SHUNT 1 & 2 CURRENT SENSING

Measurement type	True RMS measurement to allow for DC ripple
Sample Rate	5kHz or better
Input Impedance	At least 10k Ω -ve to +ve
Voltage Range	50mV to 250mV DC (absolute maximum)
Shunt Current Range	0A to 5000A, range defined by user configuration
Common mode offset from Earth	± 75 V DC (absolute maximum)
Resolution	Better than 1% full scale of max DC mV input
Accuracy	$\pm 1\%$ of full scale

3.6.1 SHUNT CONNECTION

Take care to ensure the correct polarity of the sensing wires, incorrect orientation will lead to negative current readings. To test the orientation, run the generator and supply load. Ensure all current readings are of correct polarity.

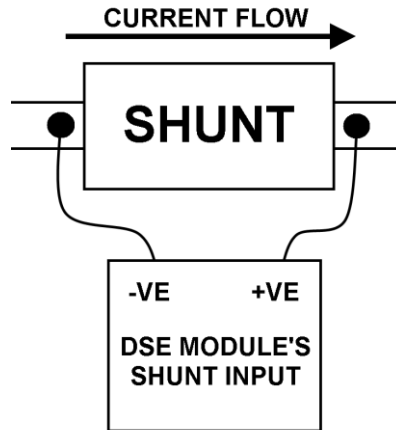

3.6.2 SHUNT ACCURACY

Ensure the correct shunts are chosen. For instance if the DSE module is providing overcurrent protection, ensure the shunt is capable of measuring the overload level you wish to protect against, and at the accuracy level you require without exceeding the maximum mV input.

For instance, this may mean fitting a larger shunt than required to measure overload currents which will reduce the resolution of the reading.

The DSE module is accurate to better than 1% of the full-scale mV reading. To maintain this accuracy you should fit accuracy class 0.5 or better.

You should check with your shunt manufacturer for further advice on selecting your shunts.

3.7 INPUTS

3.7.1 DIGITAL INPUTS

Number	11 configurable inputs
Arrangement	Contact between terminal and ground
Low level threshold	2.1V minimum
High level threshold	6.6V maximum
Maximum input voltage	+50V DC with respect to plant supply negative
Minimum input voltage	-24V DC with respect to plant supply negative
Contact wetting current	4mA typical
Open circuit voltage	12V typical

3.7.2 ANALOGUE INPUTS

3.7.2.1 OIL PRESSURE

Measurement type	Resistance measurement by measuring voltage across sensor with a fixed current applied
Arrangement	Differential resistance measurement input
Measurement current	15mA
Full scale	240 Ω
Over range / fail	270 Ω
Resolution	0.1 Bar (1-2 PSI)
Accuracy	$\pm 2\%$ of full scale resistance ($\pm 4.8\Omega$) excluding transducer error
Max common mode voltage	$\pm 2V$
Display range	0bar-17.2 bar (0PSI-250PSI) subject to limits of the sensor

3.7.2.2 COOLANT TEMPERATURE

Can be configured as a flexible sensor.

Measurement type	Resistance measurement by measuring voltage across sensor with a fixed current applied
Arrangement	Differential resistance measurement input
Measurement current	10mA
Full scale	480 Ω
Over range / fail	540 Ω
Resolution	1 $^{\circ}C$ (2 $^{\circ}F$)
Accuracy	$\pm 2\%$ of full scale resistance ($\pm 9.6\Omega$) excluding transducer error
Max common mode voltage	$\pm 2V$
Display range	0 $^{\circ}C$ -250 $^{\circ}C$ (32 $^{\circ}F$ - 482 $^{\circ}F$) subject to limits of the sensor

3.7.2.3 FUEL LEVEL

Can be configured as a flexible sensor.

Measurement type	Resistance measurement by measuring voltage across sensor with a fixed current applied
Arrangement	Differential resistance measurement input
Measurement current	10mA
Full scale	480Ω
Over range / fail	540Ω
Resolution	1%
Accuracy	+/-2% of full scale resistance ($\pm 9.6\Omega$) excluding transducer error
Max common mode voltage	$\pm 2V$
Display range	0%-250% subject to limits of the sensor

3.7.2.4 BATTERY TEMPERATURE

Can be configured as a flexible sensor.

Measurement type	Resistance measurement by measuring voltage across sensor with a fixed current applied
Arrangement	Differential resistance measurement input
Measurement current	10mA
Full scale	480Ω
Over range / fail	540Ω
Resolution	1°C (2°F)
Accuracy	+/-2% of full scale resistance ($\pm 9.6\Omega$) excluding transducer error
Max common mode voltage	$\pm 2V$
Display range	0°C -250°C (32°F - 482°F) subject to limits of the sensor

3.7.2.5 FLEXIBLE SENSOR (THROUGH CONFIGURATION)

Measurement type	Resistance measurement by measuring voltage across sensor with a fixed current applied
Arrangement	Differential resistance measurement input
Measurement current	10mA
Full scale	480Ω
Over range / fail	540Ω
Resolution	1%
Accuracy	$\pm 2\%$ of full scale resistance ($\pm 9.6\Omega$) excluding transducer error
Max common mode voltage	$\pm 2V$
Display range	0%-250%, 0°C -250°C or 0PSI-250PSI

3.7.3 CHARGE FAIL INPUT

Minimum voltage	0V
Maximum voltage	35V (plant supply)
Resolution	0.2V
Accuracy	± 1% of max measured voltage
Excitation	Active circuit constant power output
Output Power	2.5W Nominal @12V and 24V
Current at 12V	210mA
Current at 24V	105mA

The charge fail input is actually a combined input and output. Whenever the generator is required to run, the terminal provides excitation current to the charge alternator field winding. When the charge alternator is correctly charging the battery, the voltage of the terminal is close to the plant battery supply voltage. In a failed charge situation, the voltage of this terminal is pulled down to a low voltage. It is this drop in voltage that triggers the *charge failure* alarm. The level at which this operates and whether this triggers a warning or shutdown alarm is configurable using the DSE Configuration Suite Software.

3.7.4 MAGNETIC PICKUP

Type	Single ended input, capacitive coupled
Minimum voltage	0.5V RMS
Max common mode voltage	±2V
Maximum voltage	Clamped to ±70V by transient suppressers, dissipation not to exceed 1W.
Maximum frequency	10,000Hz
Resolution	6.25 RPM
Accuracy	±25 RPM
Flywheel teeth	10 to 500

 **NOTE: DSE can supply a suitable magnetic pickup device, available in two body thread lengths:**
DSE Part number 020-012 - Magnetic Pickup probe 5/8 UNF 2½" thread length
DSE Part number 020-013 - Magnetic Pickup probe 5/8 UNF 4" thread length

Magnetic Pickup devices can often be 'shared' between two or more devices. For example, one device can often supply the signal to both the module and the engine governor. The possibility of this depends upon the amount of current that the magnetic pickup can supply.

3.7.5 OUTPUTS

Ten (10) outputs are fitted to the controller.

3.7.5.1 OUTPUTS A & B

Type	Normally used for Fuel / Start outputs. Fully configurable for other purposes if the module is configured to control an electronic engine. Supplied from Emergency Stop terminal 3.
Rating	15A resistive @ 35V

3.7.5.2 CONFIGURABLE OUTPUTS C & D (LOAD SWITCHING)

Type	Fully configurable volts free relays. Output C – Normally Closed, Output D – Normally Open
Rating	8A resistive @ 250V AC
Protection	Protected against over current & over temperature. Built in load dump feature.

3.7.5.3 OUTPUTS E,F,G,H, I & J

Number	6
Type	Fully configurable, supplied from DC supply terminal 2.
Rating	2A resistive @ 35V

3.7.5.4 AVR BIAS OUTPUT

 **NOTE: Output voltage produced is dependant upon module configuration, contact the generator supplier for more information.**

 **NOTE: Connection for an AVR is only available on DSE7450 version 2 and onwards.**

Output Range	0 V DC to 10 V DC floating.
Isolated	Optically isolated to 5000 V
Minimum Load Impedance	1 kΩ
Resolution	5 mV
Accuracy	±1 % of full scale

3.8 COMMUNICATION PORTS

USB Port	USB2.0 Device for connection to PC running DSE configuration suite only Max distance 6m (yards)
Serial Communication	RS232 and RS485 are both fitted but and provide independent operation
RS232 Serial port	Non – Isolated port Max Baud rate 115K baud subject to S/W TX, RX, RTS, CTS, DSR, DTR, DCD Male 9 way D type connector Max distance 15m (50 feet)
RS485 Serial port	Isolated Data connection 2 wire + common Half Duplex Data direction control for Transmit (by s/w protocol) Max Baud Rate 19200 External termination required (120Ω) Max common mode offset 70V (on board protection transorb) Max distance 1.2km (¾ mile)
CAN Port	Engine CAN Port Standard implementation of 'Slow mode', up to 250K bits/s Non-Isolated. Internal Termination provided (120Ω) Max distance 40m (133 feet)
 NOTE: For additional length, the DSE124 CAN Extender is available. Please refer to DSE Publication: 057-116 DSE124 Operator Manual for more information.	
Ethernet	Auto detecting 10/100 Ethernet port. RJ45 socket Max distance 100m (333 feet) between routers.

3.9 COMMUNICATION PORT USAGE

3.9.1 CAN INTERFACE

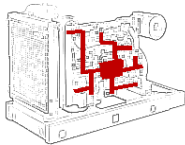

Modules are fitted with the CAN interface as standard and are capable of receiving engine data from engine CAN controllers compliant with the CAN standard. CAN enabled engine controllers monitor the engine's operating parameters such as engine speed, oil pressure, engine temperature (among others) in order to closely monitor and control the engine. The industry standard communications interface (CAN) transports data gathered by the engine controller interface. This allows generator controllers to access these engine parameters with no physical connection to the sensor device.

 **NOTE: For further details for connections to CAN enabled engines and the functions available with each engine type, refer to the manual *Electronic Engines and DSE Wiring*. Part No. 057-004**

3.9.2 USB CONNECTION

The USB port is provided to give a simple means of connection between a PC and the controller. Using the DSE Configuration Suite Software, the operator is then able to control the module, starting or stopping the generator, selecting operating modes, etc. Additionally, the various operating parameters (such as output volts, oil pressure, etc.) of the remote generator are available to be viewed or changed.

To connect a module to a PC by USB, the following items are required:

- DSE7450 Controller
- DSE Configuration Suite PC Software (Supplied on configuration suite software CD or available from www.deepseapl.com).
- USB cable Type A to Type B. (This is the same cable as often used between a PC and a USB printer)



DSE can supply this cable if required :
PC Configuration interface lead (USB type A – type B) DSE Part No 016-125

NOTE: The DC supply must be connected to the module for configuration by PC.

NOTE: Refer to DSE7450 PC Configuration Suite Manual (DSE part 057-169) for further details on configuring, monitoring and control.

3.9.3 USB HOST-MASTER (USB DRIVE CONNECTION)

USB Type A connection for USB Host facility for USB storage device for data recording. Maximum size of externally storage device is 16Gb (see viewing the instrument pages)

NOTE: Refer to DSE7450 PC Configuration Suite Manual (DSE part 057-169) for further details on configuring, monitoring and control.

3.9.4 RS232

The RS232 port on the controller supports the Modbus RTU protocol.

The Gencomm register table for the controller is available upon request from the DSE Technical Support Department.

RS232 is for short distance communication (max 15m) and is typically used to connect the controller to a telephone or GSM modem for more remote communications.

Many PCs are not fitted with an internal RS232 serial port. DSE DOES NOT recommend the use of USB to RS232 convertors but can recommend PC add-ons to provide the computer with an RS232 port.

3.9.4.1 RECOMMENDED PC RS232 SERIAL PORT ADD-ONS

Remember to check these parts are suitable for your PC. Consult your PC supplier for further advice.

- Brainboxes PM143 PCMCIA RS232 card (for laptop PCs)



- Brainboxes VX-001 Express Card RS232 (for laptops and nettops PCs)



- Brainboxes UC246 PCI RS232 card (for desktop PCs)



- Brainboxes PX-246 PCI Express 1 Port RS232 1 x 9 Pin (for desktop PCs)



Supplier:

Brainboxes

Tel: +44 (0)151 220 2500

Web: <http://www.brainboxes.com>

Email: Sales: sales@brainboxes.com

NB DSE Have no business tie to Brainboxes. Over many years, our own engineers have used these products and are happy to recommend them.

3.9.4.2 RECOMMENDED EXTERNAL MODEMS:

- Multitech Global Modem – MultiModem ZBA (PSTN)
DSE Part Number 020-252
(Contact DSE Sales for details of localisation kits for these modems)



- Sierra Fastrak Xtend GSM modem kit (PSU, Antenna and modem)*
DSE Part number 0830-001-01



NOTE: For GSM modems a SIM card is required, supplied by your GSM network provider

- For SMS only, a 'normal' voice SIM card is required. This enables the controller to send SMS messages to designated mobile phones upon status and alarm conditions.
- For a data connection to a PC running DSE Configuration Suite Software, a 'special' CSD (Circuit Switched Data) SIM card is required that will enable the modem to answer an incoming data call. Many 'pay as you go' services will not provide a CSD (Circuit Switched Data) SIM card.

3.9.5 RS485

The RS485 port on the series controller supports the Modbus RTU protocol.

The DSE Gencomm register table for the controller is available upon request from the DSE Technical Support Department.

RS485 is used for point-to-point cable connection of more than one device (maximum 32 devices) and allows for connection to PCs, PLCs and Building Management Systems (to name just a few devices).

One advantage of the RS485 interface is the large distance specification (1.2km when using Belden 9841 (or equivalent) cable. This allows for a large distance between the module and a PC running the DSE Configuration Suite software. The operator is then able to control the module, starting or stopping the generator, selecting operating modes, etc.

The various operating parameters (such as output volts, oil pressure, etc.) of the remote generator can be viewed or changed.

NOTE: For a single module to PC connection and distances up to 6m (8yds) the USB connection method is more suitable and provides for a lower cost alternative to RS485 (which is more suited to longer distance connections).

3.9.5.1 RECOMMENDED PC RS485 SERIAL PORT ADD-ONS

Remember to check these parts are suitable for your PC. Consult your PC supplier for further advice.

- Brainboxes PM154 PCMCIA RS485 card (for laptops PCs)
Set to 'Half Duplex, Autogating" with 'CTS True' set to 'enabled'
- Brainboxes VX-023 ExpressCard 1 Port RS422/485 (for laptops and nettop PCs)
- Brainboxes UC320 PCI Velocity RS485 card (for desktop PCs)
Set to 'Half Duplex, Autogating" with 'CTS True' set to 'enabled'
- Brainboxes PX-324 PCI Express 1 Port RS422/485 (for desktop PCs)



Supplier:

Brainboxes

Tel: +44 (0)151 220 2500

Web: <http://www.brainboxes.com>

Email: Sales: sales@brainboxes.com

NB DSE have no business tie to Brainboxes. Over many years,our own engineers have used these products and are happy to recommend them.

3.9.6 ETHERNET

The Ethernet port on the series controller supports the Modbus TCP protocol.

The DSE Gencomm register table for the controller is available upon request from the DSE Technical Support Department.

Ethernet is used for point-to-point cable connection of more than one device and allows for connection to PCs, PLCs and Building Management Systems (to name just a few devices).

One advantage of the Ethernet interface is the ability to interface into an existing LAN (Local Area Network) connection for remote connection via an internet connection. This allows for a large distance between the module and a PC running the DSE Configuration Suite software. The operator is then able to control the module, starting or stopping the generator, selecting operating modes, etc.

The various operating parameters (such as output volts, oil pressure, etc.) of the remote generator can be viewed or changed.

 **NOTE: For a single module to PC connection and distances up to 6m (8yds) the USB connection method is more suitable and provides for a lower cost alternative to Ethernet (which is more suited to longer distance connections).**

3.9.6.1 DIRECT PC CONNECTION





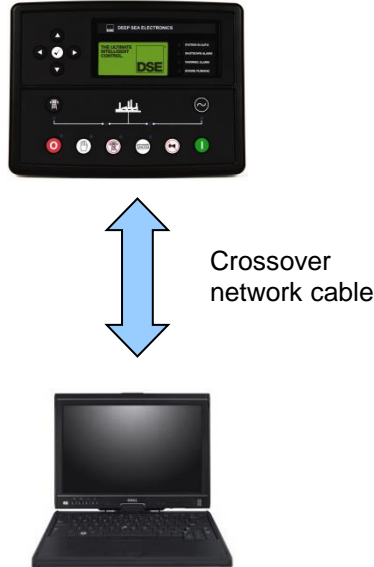





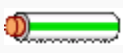





Requirements

- Crossover Ethernet cable (see Below)
- PC with Ethernet port



Crossover cable wiring detail

Two pairs crossed, two pairs uncrossed
10baseT/100baseTX crossover

Pin	Connection 1 (T568A)	Connection 2 (T568B)
1	 white/green stripe	 white/orange stripe
2	 green solid	 orange solid
3	 white/orange stripe	 white/green stripe
4	 blue solid	 blue solid
5	 white/blue stripe	 white/blue stripe
6	 orange solid	 green solid
7	 white/brown stripe	 white/brown stripe
8	 brown solid	 brown solid

For the advanced Engineer, a crossover cable is a CAT5 cable with one end terminated as T568A and the other end terminated as T568B.

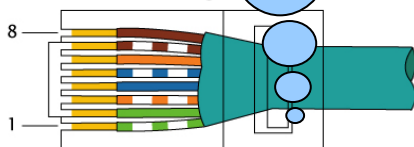

EIA/TIA-568A

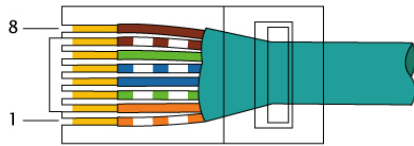

EIA/TIA-568B

NOTE: This cable can be purchased from any good PC or IT store.

3.9.6.2 CONNECTION TO BASIC ETHERNET





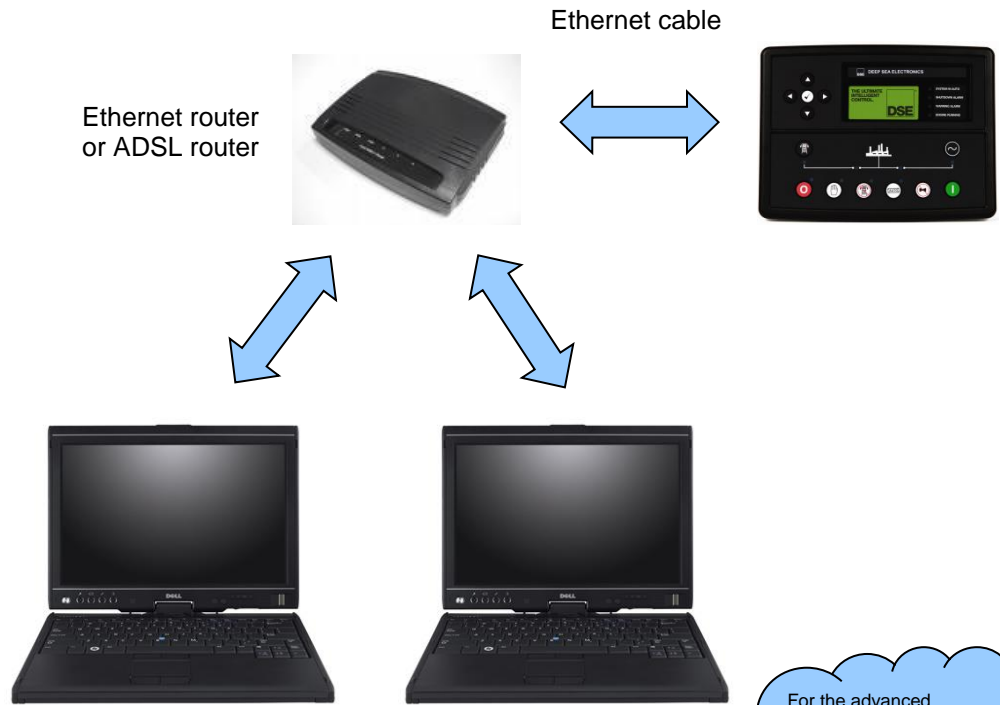







Requirements

- Ethernet cable (see below)
- Working Ethernet (company or home network)
- PC with Ethernet port

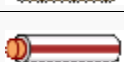
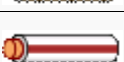

Ethernet cable wiring detail

10baseT/100baseT

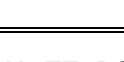
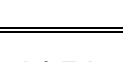
Pin	Connection 1 (T568A)	Connection 2 (T568A)
1	 white/green stripe	 white/green stripe
2	 green solid	 green solid
3	 white/orange stripe	 white/orange stripe
4	 blue solid	 blue solid
5	 white/blue stripe	 white/blue stripe
6	 orange solid	 orange solid
7	 white/brown stripe	 white/brown stripe
8	 brown solid	 brown solid

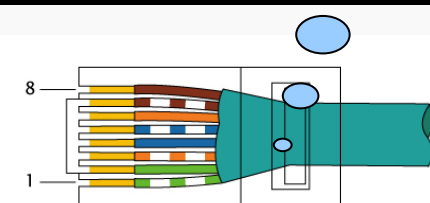

EIA/TIA-568A

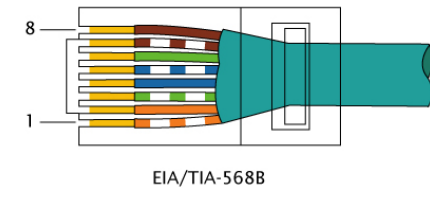

EIA/TIA-568B

NOTE: DSE Stock a 2m (2yds) Ethernet Cable – Part number 016-137. Alternatively they can be purchased from any good PC or IT store.

3.9.6.3 CONNECTION TO COMPANY INFRASTRUCTURE ETHERNET





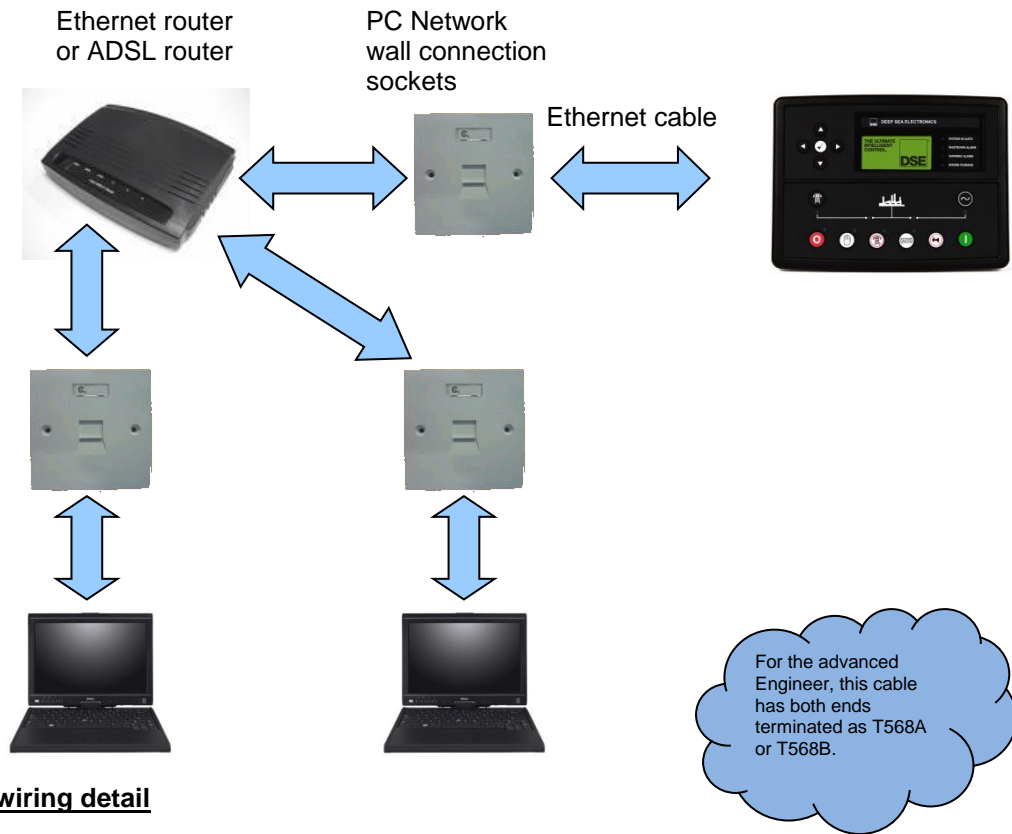







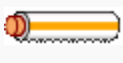
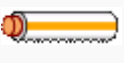

Requirements

- Ethernet cable (see below)
- Working Ethernet (company or home network)
- PC with Ethernet port

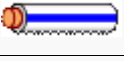

Ethernet cable wiring detail

10baseT/100baseT

Pin	Connection 1 (T568A)	Connection 2 (T568A)
1	 white/green stripe	 white/green stripe
2	 green solid	 green solid
3	 white/orange stripe	 white/orange stripe
4	 blue solid	 blue solid
5	 white/blue stripe	 white/blue stripe
6	 orange solid	 orange solid
7	 white/brown stripe	 white/brown stripe
8	 brown solid	 brown solid

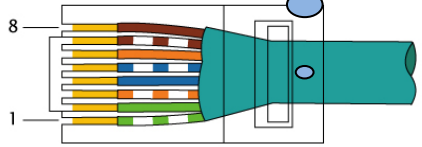

EIA/TIA-568A

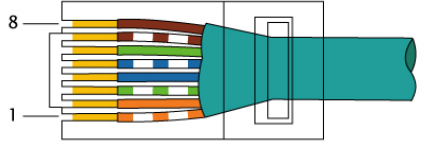

EIA/TIA-568B

NOTE: DSE Stock a 2m (2yds) Ethernet Cable – Part number 016-137. Alternatively they can be purchased from any good PC or IT store.

3.9.6.4 CONNECTION TO THE INTERNET

Requirements

- Ethernet cable (see below)
- Working Ethernet (company or home network)
- Working Internet connection (ADSL or DSL recommended)

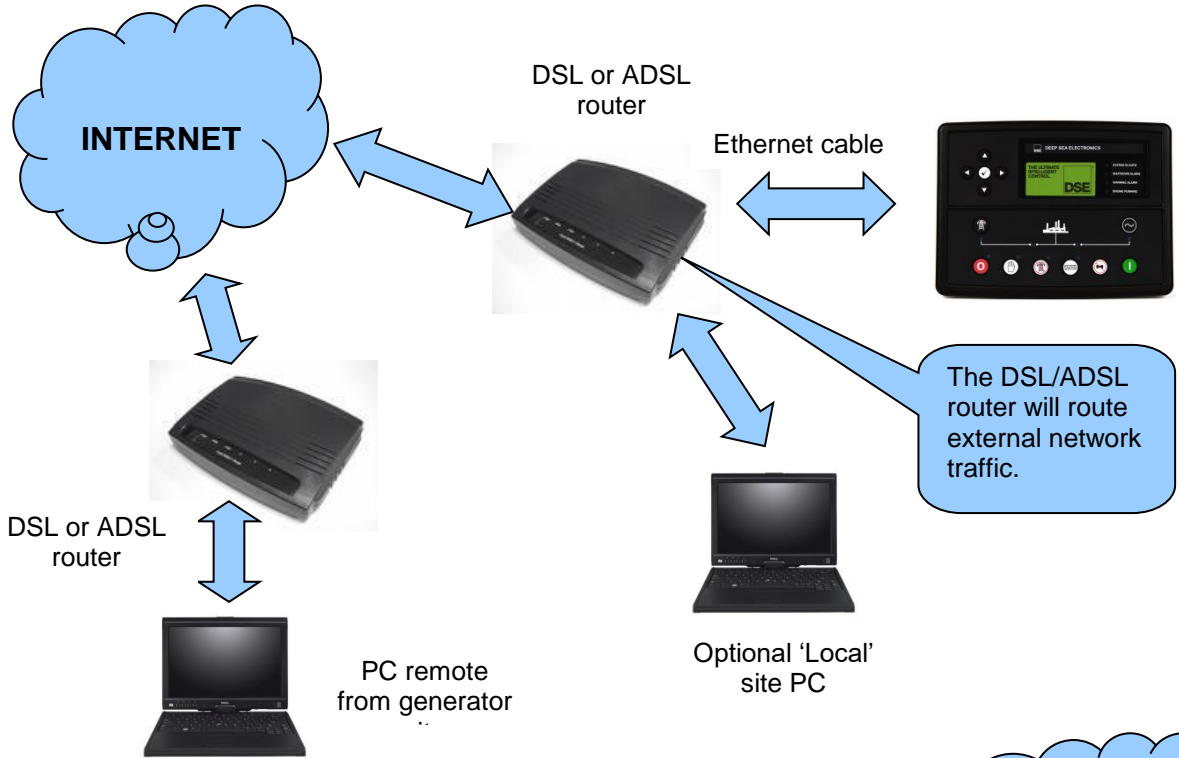

For the advanced Engineer, this cable has both ends terminated as T568A (as shown below) or T568B.

Ethernet cable wiring detail

10baseT/100baseT

Pin	Connection 1 (T568A)	Connection 2 (T568A)
1	white/green stripe	white/green stripe
2	green solid	green solid
3	white/orange stripe	white/orange stripe
4	blue solid	blue solid
5	white/blue stripe	white/blue stripe
6	orange solid	orange solid
7	white/brown stripe	white/brown stripe
8	brown solid	brown solid

NOTE: DSE Stock a 2m (2yds) Ethernet Cable – Part number 016-137. Alternatively they can be purchased from any good PC or IT store.

3.9.6.5 FIREWALL CONFIGURATION FOR INTERNET ACCESS

As modem/routers differ enormously in their configuration, it is not possible for DSE to give a complete guide to their use with the module. However it is possible to give a description of the requirements in generic terms. For details of how to achieve the connection to your modem/router you are referred to the supplier of your modem/router equipment.

The module makes its data available over Modbus TCP and as such communicates over the Ethernet using a Port configured via the DSE Configuration Suite software.

You must configure your modem/router to allow inbound traffic on this port. For more information you are referred to your WAN interface device (modem/router) manufacturer.

It is also important to note that if the port assigned (setting from software "Modbus Port Number") is already in use on the LAN, the module cannot be used and another port must be used.

Outgoing Firewall rule

As the module makes its user interface available to standard web browsers, all communication uses the chosen port. It is usual for a firewall to make the same port outgoing open for communication.

Incoming traffic (virtual server)

Network Address and Port Translation (NAPT) allows a single device, such as the modem/router gateway, to act as an agent between the Internet (or "public external network") and a local (or "internal private") network. This means that only a single, unique IP address is required to represent an entire group of computers.

For our application, this means that the WAN IP address of the modem/router is the IP address we need to access the site from an external (internet) location.

When the requests reach the modem/router, we want this passed to a 'virtual server' for handling, in our case this is the module.

Result : Traffic arriving from the WAN (internet) on port xxx is automatically sent to IP address set within the configuration software on the LAN for handling.



NOTE: Refer to DSE7450 PC Configuration Suite Manual (DSE part 057-169) for further details on configuring, monitoring and control.

3.10 DSENET® FOR EXPANSION MODULES

DSENet® is the interconnection cable between the host controller and the expansion module(s) and must not be connect to any device other than DSE equipment designed for connection to the DSENet®

Cable type	Two core screened twisted pair
Cable characteristic impedance	120Ω
Recommended cable	Belden 9841 Belden 9271
Maximum cable length	1200m (¾ mile) when using Belden 9841 or direct equivalent. 600m (666 yds) when using Belden 9271 or direct equivalent.
DSENet® topology	“Daisy Chain” Bus with no stubs (spurs)
DSENet® termination	120Ω. Fitted internally to host controller. Must be fitted externally to the ‘last’ expansion module by the customer.
Maximum expansion modules	Total 20 devices made up of DSE2130 (up to 4), DSE2131 (up to 4), DSE2133 (up to 4), DSE2152 (up to 4), DSE2157 (up to 10), DSE2548 (up to 10) This gives the possibility of : Maximum 32 additional 0-10V or 4-20mA outputs (DSE2152) Maximum 80 additional Relay outputs (DSE2157) Maximum 80 additional LED indicators Maximum 24 additional Ratio-metric or Thermocouple inputs (DSE2133). Maximum 40 additional inputs (All can be configured as either digital, resistive, 0-10V or 4-20mA when using DSE2131)

NOTE: As a termination resistor is internally fitted to the host controller, the host controller must be the ‘first’ unit on the DSENet®. A termination resistor **MUST** be fitted to the ‘last’ unit on the DSENet®. For connection details, you are referred to the section entitled ‘typical wiring diagram’ elsewhere in this document.

NOTE: The DSE7450 module does not support the DSE2510/2520 remote display modules.

3.10.1 DSENET® USED FOR MODBUS ENGINE CONNECTION

As DSENet® utilises an RS485 hardware interface, this port can be configured for connection to Cummins Modbus engines (Engines fitted with Cummins GCS). This leaves the RS485 interface free for connection to remote monitoring equipment (i.e. Building Management System, PLC or PC RS485 port).

While this is a very useful feature in some applications, the obvious drawback is that the DSENet® interface is no longer available for connection to expansion devices.

Example of configuring the DSENet® for connection to Cummins QST GCS using the DSE Configuration Suite Software:

ECU (ECM) Options

Engine Type: Cummins QST

Enhanced J1939:

Alternative Engine Speed:

Modbus Engine Comms Port: DSENet Port

3.11 SOUNDER

The module features an internal sounder to draw attention to warning, shutdown and electrical trip alarms.

Sounder level	64db @ 1m
---------------	-----------

3.11.1 ADDING AN EXTERNAL SOUNDER TO THE APPLICATION

Should an external alarm or indicator be required, this can be achieved by using the DSE Configuration Suite PC software to configure an auxiliary output for “Audible Alarm”, and by configuring an auxiliary input for “Alarm Mute” (if required).

The audible alarm output activates and de-activates at the same time as the module’s internal sounder. The Alarm mute input and internal alarm mute button activate ‘in parallel’ with each other. Either signal will mute both the internal sounder and audible alarm output.

Example of configuration to achieve external sounder with external alarm mute button:

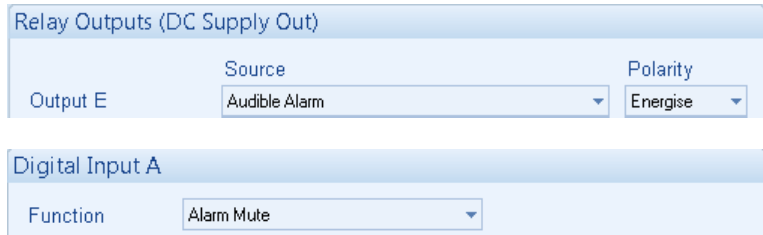

3.12 ACCUMULATED INSTRUMENTATION

NOTE: When an accumulated instrumentation value exceeds the maximum number as listed below, it will reset and begin counting from zero again.

Engine hours run	Maximum 99999 hrs 59 minutes (approximately 11yrs 4months)
Number of starts	1,000,000 (1 million)

The number of logged Engine Hours and Number of Starts can be set/reset using the DSE Configuration Suite PC software. Depending upon module configuration, this may have been PIN number locked by your generator supplier

3.13 DIMENSIONS AND MOUNTING

3.13.1 DIMENSIONS

240.0mm x 181.1mm x 41.7mm (9.4" x 7.1" x 1.6")

3.13.2 PANEL CUTOUT

220mm x 160mm (8.7" x 6.3")

3.13.3 WEIGHT

0.7kg (1.4lb)

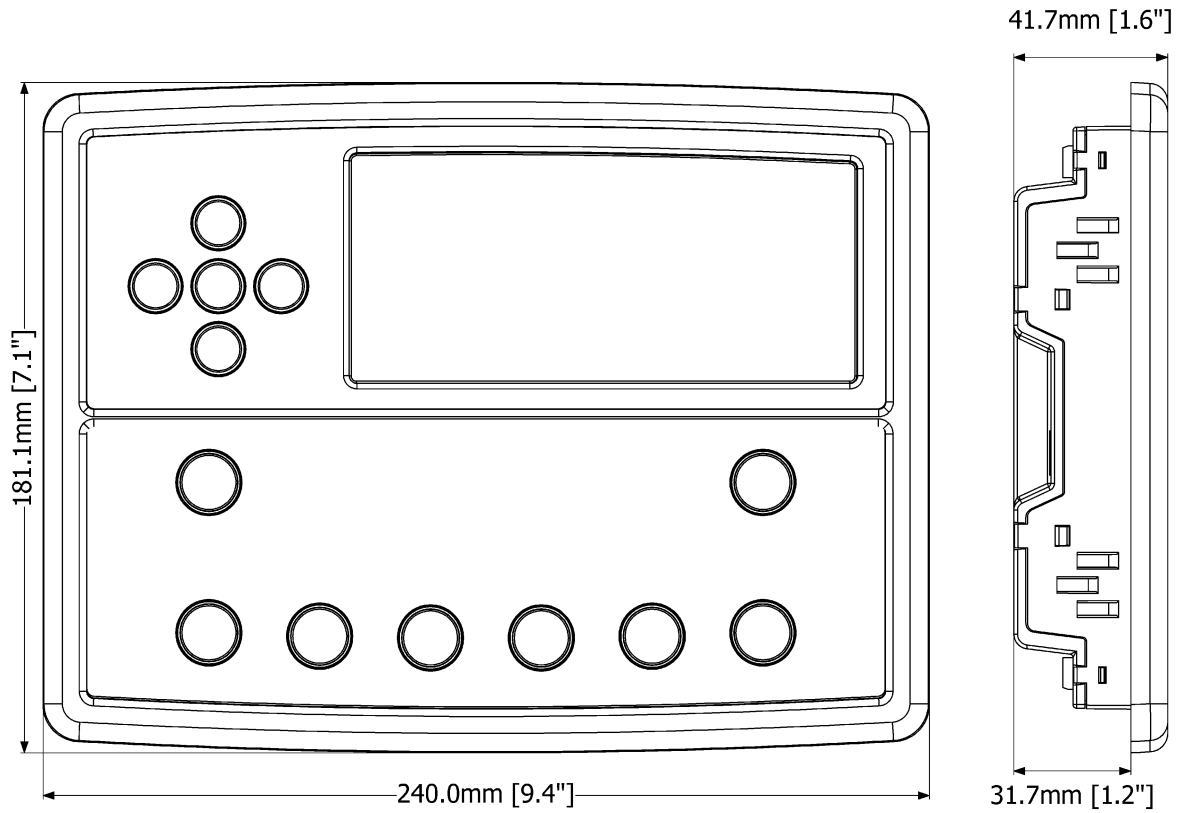

3.13.4 FIXING CLIPS

The module is held into the panel fascia using the supplied fixing clips.

- Withdraw the fixing clip screw (turn anticlockwise) until only the pointed end is protruding from the clip.
- Insert the three 'prongs' of the fixing clip into the slots in the side of the module case.
- Pull the fixing clip backwards (towards the back of the module) ensuring all three prongs of the clip are inside their allotted slots.
- Turn the fixing clip screws clockwise until they make contact with the panel fascia.
- Turn the screws a little more to secure the module into the panel fascia. Care should be taken not to over tighten the fixing clip screws.

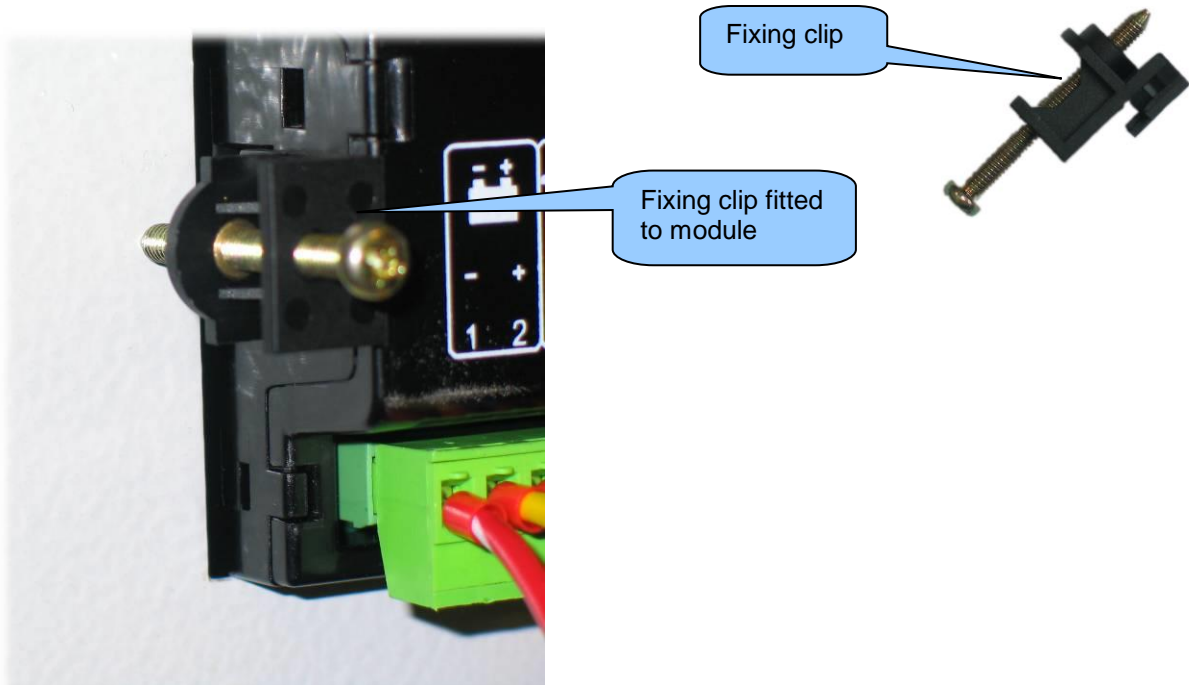

NOTE: In conditions of excessive vibration, mount the module on suitable anti-vibration mountings.

3.13.5 CABLE TIE FIXING POINTS

Integral cable tie fixing points are included on the rear of the module's case to aid wiring. This additionally provides strain relief to the cable loom by removing the weight of the loom from the screw connectors, thus reducing the chance of future connection failures.

Care should be taken not to over tighten the cable tie (for instance with cable tie tools) to prevent the risk of damage to the module case.



Cable tie fixing point

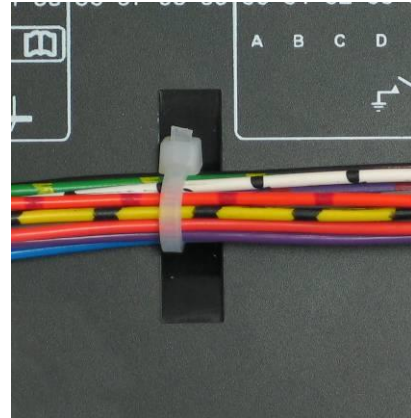

With cable and tie in place

3.13.6 SILICON SEALING GASKET

The supplied silicon gasket provides improved sealing between module and the panel fascia.

The gasket is fitted to the module before installation into the panel fascia.

Take care to ensure the gasket is correctly fitted to the module to maintain the integrity of the seal.

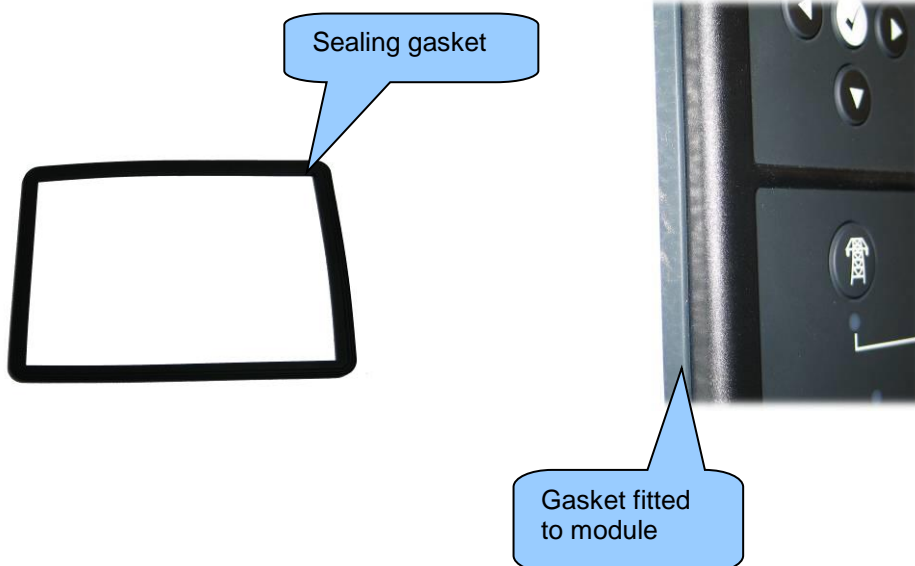

3.13.7 APPLICABLE STANDARDS

BS 4884-1	This document conforms to BS4884-1 1992 Specification for presentation of essential information.
BS 4884-2	This document conforms to BS4884-2 1993 Guide to content
BS 4884-3	This document conforms to BS4884-3 1993 Guide to presentation
BS EN 60068-2-1 (Minimum temperature)	-30°C (-22°F)
BS EN 60068-2-2 (Maximum temperature)	+70°C (158°F)
BS EN 60950	Safety of information technology equipment, including electrical business equipment
BS EN 61000-6-2	EMC Generic Immunity Standard (Industrial)
BS EN 61000-6-4	EMC Generic Emission Standard (Industrial)
BS EN 60529 (Degrees of protection provided by enclosures)	IP65 (front of module when installed into the control panel with the supplied sealing gasket) IP42 (front of module when installed into the control panel WITHOUT being sealed to the panel)
UL508 NEMA rating (Approximate)	12 (Front of module when installed into the control panel with the supplied sealing gasket). 2 (Front of module when installed into the control panel WITHOUT being sealed to the panel)
IEEE C37.2 (Standard Electrical Power System Device Function Numbers and Contact Designations)	<p>Under the scope of IEEE 37.2, <i>function numbers can also be used to represent functions in microprocessor devices and software programs.</i> The controller is device number 11L-8000 (Multifunction device protecting Line (generator) –module).</p> <p>As the module is configurable by the generator OEM, the functions covered by the module will vary. Under the module's factory configuration, the device numbers included within the module are :</p> <ul style="list-style-type: none"> 2 – Time delay starting or closing relay 3 – Checking or interlocking relay 5 – Stopping Device 6 – Starting circuit breaker 8 – Control power disconnecting device 10 – Unit sequence switch 11 – Multifunction device 12 – Overspeed device 14 – Underspeed device 23 – Temperature control device 26 – Apparatus thermal device 27AC – AC undervoltage relay 27DC – DC undervoltage relay 29 – Isolating contactor or switch 30 – Annunciator relay 31 – Separate Excitation Device 37 – Undercurrent or underpower relay 41 – Field circuit breaker 42 – Running circuit breaker 44 – Unit sequence relay 48 – Incomplete sequence relay 49 – Machine or transformer thermal relay

Continued overleaf.

Specification

IEEE C37.2 (Standard Electrical Power System Device Function Numbers and Contact Designations)	Continued... 50 – Instantaneous overcurrent relay 52 – AC circuit breaker 53 – Exciter or DC generator relay 54 – Turning gear engaging device 59AC – AC overvoltage relay 59DC – DC overvoltage relay 62 – Time delay stopping or opening relay 63 – Pressure switch 71 – Level switch 74 – Alarm relay 78 – Phase-angle measuring relay 79 – Reclosing relay (USING INTERNAL PLC EDITOR) 81 – Frequency relay 83 – Automatic selective control or transfer relay 86 – Lockout relay
---	---

In line with our policy of continual development, Deep Sea Electronics, reserve the right to change specification without notice.

3.13.8 ENCLOSURE CLASSIFICATIONS

3.13.8.1 IP CLASSIFICATIONS

The modules specification under BS EN 60529 Degrees of protection provided by enclosures

IP65 (Front of module when module is installed into the control panel with the optional sealing gasket).

IP42 (front of module when module is installed into the control panel WITHOUT being sealed to the panel)

First Digit	Second Digit
Protection against contact and ingress of solid objects 0 No protection	Protection against ingress of water 0 No protection
1 Protected against ingress solid objects with a diameter of more than 50 mm. No protection against deliberate access, e.g. with a hand, but large surfaces of the body are prevented from approach.	1 Protection against dripping water falling vertically. No harmful effect must be produced (vertically falling drops).
2 Protected against penetration by solid objects with a diameter of more than 12 mm. Fingers or similar objects prevented from approach.	2 Protection against dripping water falling vertically. There must be no harmful effect when the equipment (enclosure) is tilted at an angle up to 15° from its normal position (drops falling at an angle).
3 Protected against ingress of solid objects with a diameter of more than 2.5 mm. Tools, wires etc. with a thickness of more than 2.5 mm are prevented from approach.	3 Protection against water falling at any angle up to 60° from the vertical. There must be no harmful effect (spray water).
4 Protected against ingress of solid objects with a diameter of more than 1 mm. Tools, wires etc. with a thickness of more than 1 mm are prevented from approach.	4 Protection against water splashed against the equipment (enclosure) from any direction. There must be no harmful effect (splashing water).
5 Protected against harmful dust deposits. Ingress of dust is not totally prevented but the dust must not enter in sufficient quantity to interfere with satisfactory operation of the equipment. Complete protection against contact.	5 Protection against water projected from a nozzle against the equipment (enclosure) from any direction. There must be no harmful effect (water jet).
6 Protection against ingress of dust (dust tight). Complete protection against contact.	6 Protection against heavy seas or powerful water jets. Water must not enter the equipment (enclosure) in harmful quantities (splashing over).

3.13.8.2 NEMA CLASSIFICATIONS

THE MODULES NEMA RATING (APPROXIMATE)

12 (Front of module when module is installed into the control panel with the optional sealing gasket).

2 (front of module when module is installed into the control panel WITHOUT being sealed to the panel)

 **NOTE: There is no direct equivalence between IP / NEMA ratings. IP figures shown are approximate only.**

1 IP30	Provides a degree of protection against contact with the enclosure equipment and against a limited amount of falling dirt.
2 IP31	Provides a degree of protection against limited amounts of falling water and dirt.
3 IP64	Provides a degree of protection against windblown dust, rain and sleet; undamaged by the formation of ice on the enclosure.
3R IP32	Provides a degree of protection against rain and sleet;; undamaged by the formation of ice on the enclosure.
4 (X) IP66	Provides a degree of protection against splashing water, windblown dust and rain, hose directed water; undamaged by the formation of ice on the enclosure. (Resist corrosion).
12/12K IP65	Provides a degree of protection against dust, falling dirt and dripping non corrosive liquids.
13 IP65	Provides a degree of protection against dust and spraying of water, oil and non corrosive coolants.

4 INSTALLATION

The module is designed to be mounted on the panel fascia. For dimension and mounting details, see the section entitled *Specification, Dimension and mounting* elsewhere in this document.





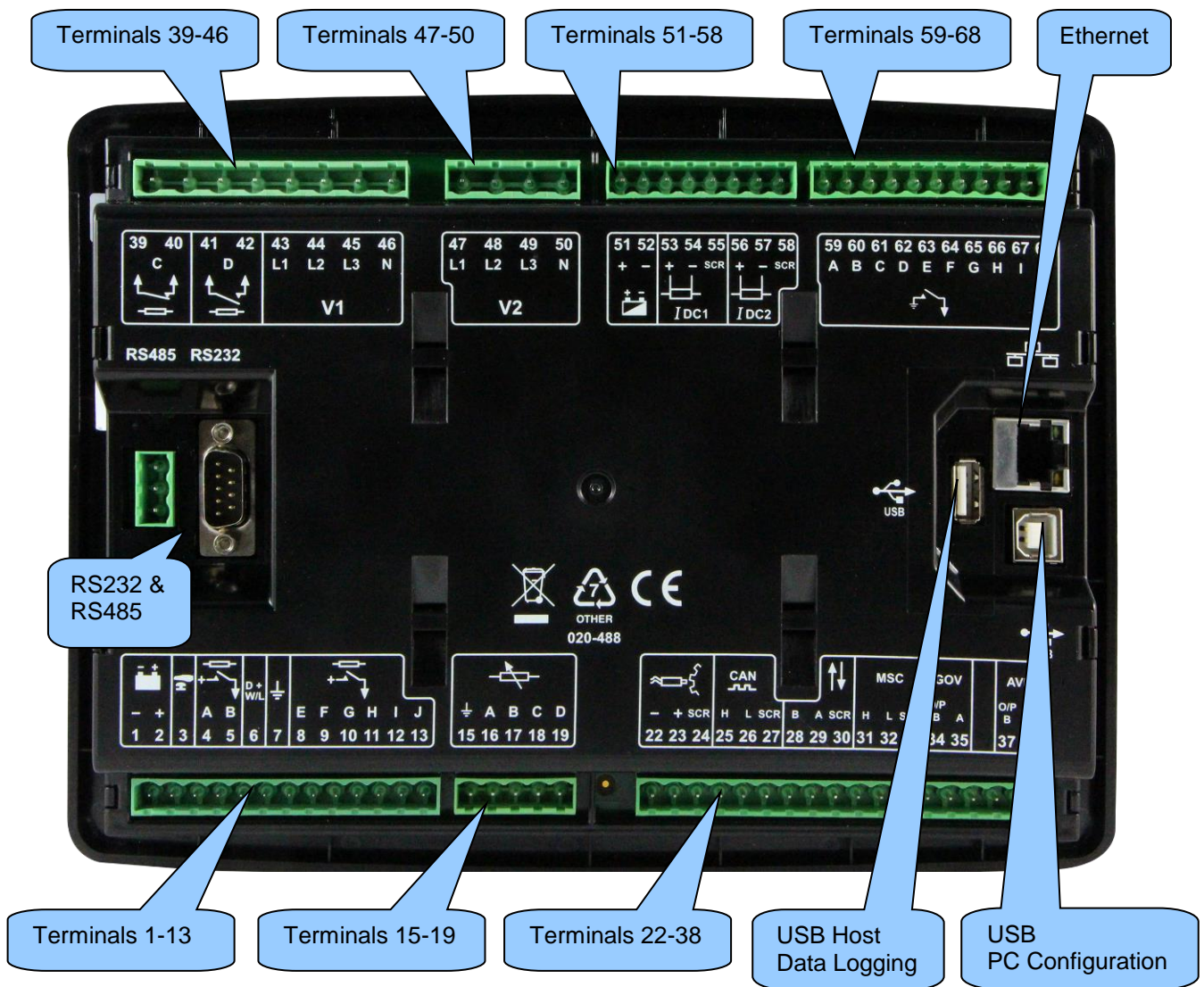

4.1 TERMINAL DESCRIPTION

To aid user connection, icons are used on the rear of the module to help identify terminal functions. An example of this is shown below.

NOTE: Availability of some terminals depends upon module version. Full details are given in the section entitled *Terminal Description* elsewhere in this manual.



4.1.1 DC SUPPLY, FUEL AND START OUTPUTS, OUTPUTS E-J

	PIN No	DESCRIPTION	CABLE SIZE	NOTES
	1	Engine Battery Supply Input (Negative)	2.5mm ² AWG 13	
	2	Engine Battery Supply Input (Positive)	2.5 mm ² AWG 13	(Recommended Maximum Fuse 15A anti-surge) Supplies the module (2A anti-surge requirement) and DC Outputs E,F,G, H, I & J
	3	Emergency Stop Input	2.5mm ² AWG 13	Engine Battery Supply Positive. Also supplies DC Outputs A & B. (Recommended Maximum Fuse 20A)
	4	Output Relay A (FUEL)	2.5mm ² AWG 13	Engine Battery Supply Positive from terminal 3. 15 Amp rated. Fixed as FUEL relay if electronic engine is not configured.
	5	Output Relay B (START)	2.5mm ² AWG 13	Engine Battery Supply Positive from terminal 3. 15 Amp rated. Fixed as START relay if electronic engine is not configured.
	6	Charge Fail / Excite	2.5mm ² AWG 13	Do not connect to ground (battery negative). If charge alternator is not fitted, leave this terminal disconnected.
	7	Functional Earth	2.5mm ² AWG 13	Connect to a good clean earth point.
	8	Output Relay E	1.0mm ² AWG 18	Engine Battery Supply Positive from terminal 2. 2 Amp rated.
	9	Output Relay F	1.0mm ² AWG 18	Engine Battery Supply Positive from terminal 2. 2 Amp rated.
	10	Output Relay G	1.0mm ² AWG 18	Engine Battery Supply Positive from terminal 2. 2 Amp rated.
	11	Output Relay H	1.0mm ² AWG 18	Engine Battery Supply Positive from terminal 2. 2 Amp rated.
	12	Output Relay I	1.0mm ² AWG 18	Engine Battery Supply Positive from terminal 2. 2 Amp rated.
	13	Output Relay J	1.0mm ² AWG 18	Engine Battery Supply Positive from terminal 2. 2 Amp rated.

 **NOTE: Terminal 14 is not fitted to the controller.**

 **NOTE: When the module is configured for operation with an electronic engine, FUEL and START output requirements may be different. Refer to *Electronic Engines and DSE Wiring* for further information. Part No. 057-004.**

 **NOTE: Refer to DSE7450 PC Configuration Suite Manual (DSE part 057-169) for further details on configuring, monitoring and control.**

4.1.2 ANALOGUE SENSOR

	PIN No	DESCRIPTION	CABLE SIZE	NOTES
	15	Sensor Common Return	0.5mm ² AWG 20	Return Feed For Sensors*
	16	Oil Pressure Input	0.5mm ² AWG 20	Connect To Oil Pressure Sensor
	17	Coolant Temperature Input	0.5mm ² AWG 20	Connect To Coolant Temperature Sensor
	18	Fuel Level Input	0.5mm ² AWG 20	Connect To Fuel Level Sensor
	19	Battery Temperature Input	0.5mm ² AWG 20	Connect To Battery Temperature Sensor



 **NOTE: Terminals 20 and 21 are not fitted to the controller.**

 **NOTE: It is VERY important that terminal 15 (sensor common) is soundly connected to an earth point on the ENGINE BLOCK, not within the control panel, and must be a sound electrical connection to the sensor bodies. This connection MUST NOT be used to provide an earth connection for other terminals or devices. The simplest way to achieve this is to run a SEPARATE earth connection from the system earth star point, to terminal 15 directly, and not use this earth for other connections.**

 **NOTE: If you use PTFE insulating tape on the sensor thread when using earth return sensors, ensure you do not insulate the entire thread, as this will prevent the sensor body from being earthed via the engine block.**

 **NOTE: Refer to DSE7450 PC Configuration Suite Manual (DSE part 057-169) for further details on configuring, monitoring and control.**

4.1.3 MAGNETIC PICKUP, CAN AND EXPANSION

	PIN No	DESCRIPTION	CABLE SIZE	NOTES
	22	Magnetic Pickup Negative	0.5mm ² AWG 20	Connect to Magnetic Pickup device
	23	Magnetic Pickup Positive	0.5mm ² AWG 20	Connect to Magnetic Pickup device
	24	Magnetic Pickup Screen	Shield	Connect to ground at one end only
CAN 	25	CAN Port H	0.5mm ² AWG 20	Use only 120Ω CAN approved cable
	26	CAN Port L	0.5mm ² AWG 20	Use only 120Ω CAN approved cable
	27	CAN Port Screen	0.5mm ² AWG 20	Use only 120Ω CAN approved cable
	28	DSENET Expansion +	0.5mm ² AWG 20	Use only 120Ω RS485 approved cable
	29	DSENET Expansion -	0.5mm ² AWG 20	Use only 120Ω RS485 approved cable
	30	DSENET Expansion SCR	0.5mm ² AWG 20	Use only 120Ω RS485 approved cable
MSC	31	DO NOT CONNECT		
	32	DO NOT CONNECT		
	33	DO NOT CONNECT		
GOV	34	DO NOT CONNECT		
	35	DO NOT CONNECT		
	36	DO NOT CONNECT		
AVR	37	AVR Output B (Supply)	0.5mm ² AWG 20	
	38	AVR Output A (Reference)	0.5mm ² AWG 20	

 **NOTE: Terminals 31 to 36 are not fitted to the controller.**



 **NOTE: AVR terminals 37 & 38 are only fitted to DSE7450 version 2 and onwards.**

 **NOTE: Screened cable must be used for connecting the Magnetic Pickup, ensuring that the screen is earthed at one end ONLY.**

 **NOTE: Screened 120Ω impedance cable specified for use with CAN must be used for the CAN link and the Multiset comms link. DSE stock and supply Belden cable 9841 which is a high quality 120Ω impedance cable suitable for CAN use (DSE part number 016-030)**

 **NOTE: When the module is configured for CAN operation, terminals 22, 23 & 24 should be left unconnected. Engine speed is transmitted to the controller on the CAN link. Refer to *Electronic Engines and DSE Wiring* for further information. Part No. 057-004.**

4.1.4 LOAD SWITCHING AND V1 GENERATOR AC VOLTAGE SENSING

	PIN No	DESCRIPTION	CABLE SIZE	NOTES
	39	Output Relay C	1.0mm AWG 18	Normally configured to control mains contactor coil (Recommend 10A fuse)
	40	Output Relay C	1.0mm AWG 18	Normally configured to control mains contactor coil
	41	Output Relay D	1.0mm AWG 18	Normally configured to control generator contactor coil (Recommend 10A fuse)
	42	Output Relay D	1.0mm AWG 18	Normally configured to control generator contactor coil
V1	43	Generator L1 (U) Voltage Monitoring	1.0mm ² AWG 18	Connect to generator L1 (U) output (AC) (Recommend 2A fuse)
	44	Generator L2 (V) Voltage Monitoring Input	1.0mm ² AWG 18	Connect to generator L2 (V) output (AC) (Recommend 2A fuse)
	45	Generator L3 (W) Voltage Monitoring Input	1.0mm ² AWG 18	Connect to generator L3 (W) output (AC) (Recommend 2A fuse)
	46	Generator Neutral (N) Input	1.0mm ² AWG 18	Connect to generator Neutral terminal (AC)

 **NOTE:** Refer to DSE7450 PC Configuration Suite Manual (DSE part 057-169) for further details on configuring, monitoring and control.



 **NOTE:** The above table describes connections to a three phase, four wire alternator. For alternative wiring topologies, please see the **ALTERNATIVE AC TOPOLOGIES** section of this manual.

4.1.5 MAINS AC VOLTAGE SENSING

	PIN No	DESCRIPTION	CABLE SIZE	NOTES
V2	47	Mains L1 (R) Voltage Monitoring	1.0mm AWG 18	Connect to Mains L1 (R) incoming supply (AC) (Recommend 2A fuse)
	48	Mains L2 (S) Voltage Monitoring	1.0mm AWG 18	Connect to Mains L1 (S) incoming supply (AC) (Recommend 2A fuse)
	49	Mains L3 (T) Voltage Monitoring	1.0mm AWG 18	Connect to Mains L1 (T) incoming supply (AC) (Recommend 2A fuse)
	50	Mains Neutral (N) Input	1.0mm AWG 18	Connect to Mains N incoming supply (AC)

 **NOTE:** The above table describes connections to a three phase, four wire alternator. For alternative wiring topologies, please see the **ALTERNATIVE AC TOPOLOGIES** section of this manual.

4.1.6 GENERATOR DC VOLTAGE & CURRENT SENSING

	PIN No	DESCRIPTION	CABLE SIZE	NOTES
	51	Battery Plant Supply Input Positive	1.0mm ² AWG 18	Connect to battery plant supply positive (Recommend 2A fuse)
	52	Battery Plant Supply Input Negative	1.0mm ² AWG 18	Connect to battery plant supply negative
	53	DC Shunt 1 Input Positive	1.0mm ² AWG 18	Connect to DC Shunt 1
	54	DC Shunt 1 Input Negative	1.0mm ² AWG 18	Connect to DC Shunt 1
	55	DC Shunt 1 Input Screen	Shield	Connect to ground at one end only
	56	DC Shunt 2 Input Positive	1.0mm ² AWG 18	Connect to DC Shunt 2
	57	DC Shunt 2 Input Negative	1.0mm ² AWG 18	Connect to DC Shunt 2
	58	DC Shunt 2 Input Screen	Shield	Connect to ground at one end only

4.1.6.1 SHUNT CONNECTIONS

Take care to ensure the correct polarity of the sensing wires, incorrect orientation will lead to negative current readings. To test the orientation, run the generator and supply load. Ensure all current readings are of correct polarity.

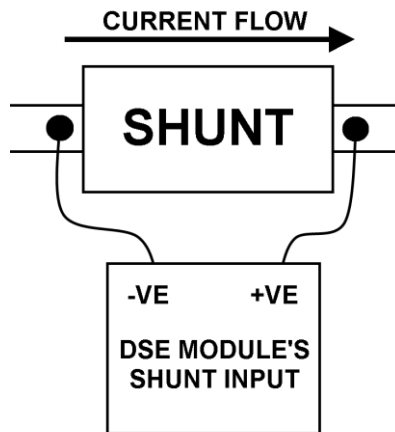



4.1.7 CONFIGURABLE DIGITAL INPUTS

Pin No	Description	Cable Size	Notes
59	Configurable Digital Input A	0.5mm ² AWG 20	Switch to negative
60	Configurable Digital Input B	0.5mm ² AWG 20	Switch to negative
61	Configurable Digital Input C	0.5mm ² AWG 20	Switch to negative
62	Configurable Digital Input D	0.5mm ² AWG 20	Switch to negative
63	Configurable Digital Input E	0.5mm ² AWG 20	Switch to negative
64	Configurable Digital Input F	0.5mm ² AWG 20	Switch to negative
65	Configurable Digital Input G	0.5mm ² AWG 20	Switch to negative
66	Configurable Digital Input H	0.5mm ² AWG 20	Switch to negative
67	Configurable Digital Input I	0.5mm ² AWG 20	Switch to negative
68	Configurable Digital Input J	0.5mm ² AWG 20	Switch to negative

NOTE: Refer to DSE7450 PC Configuration Suite Manual (DSE part 057-169) for further details on configuring, monitoring and control.

4.1.8 PC CONFIGURATION INTERFACE CONNECTOR

Description	Cable Size	Notes
 <p>Socket for connection to PC with DSE Configuration Suite Software</p>	0.5mm ² AWG 20	<p>This is a standard USB type A to type B connector.</p> 

NOTE: The USB connection cable between the PC and the module must not be extended beyond 5m (yards). For distances over 5m, it is possible to use a third party USB extender. Typically, they extend USB up to 50m (yards). The supply and support of this type of equipment is outside the scope of Deep Sea Electronics PLC.

CAUTION! Care must be taken not to overload the PC's USB system by connecting more than the recommended number of USB devices to the PC. For further information, consult your PC supplier.

CAUTION! This socket must not be used for any other purpose.

4.1.9 RS232 CONNECTOR

PIN No	Notes
1	Received Line Signal Detector (Data Carrier Detect)
2	Received Data
3	Transmit Data
4	Data Terminal Ready
5	Signal Ground
6	Data Set Ready
7	Request To Send
8	Clear To Send
9	Ring Indicator

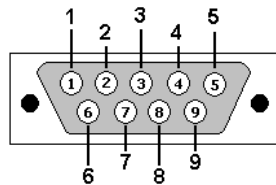

View looking into the male connector on the module

4.1.10 RS485 CONNECTOR

PIN No	Notes
A (-)	Two core screened twisted pair cable. 120Ω impedance suitable for RS485 use.
B (+)	Recommended cable type - Belden 9841
SCR	Max distance 1200m (1.2km) when using Belden 9841 or direct equivalent.

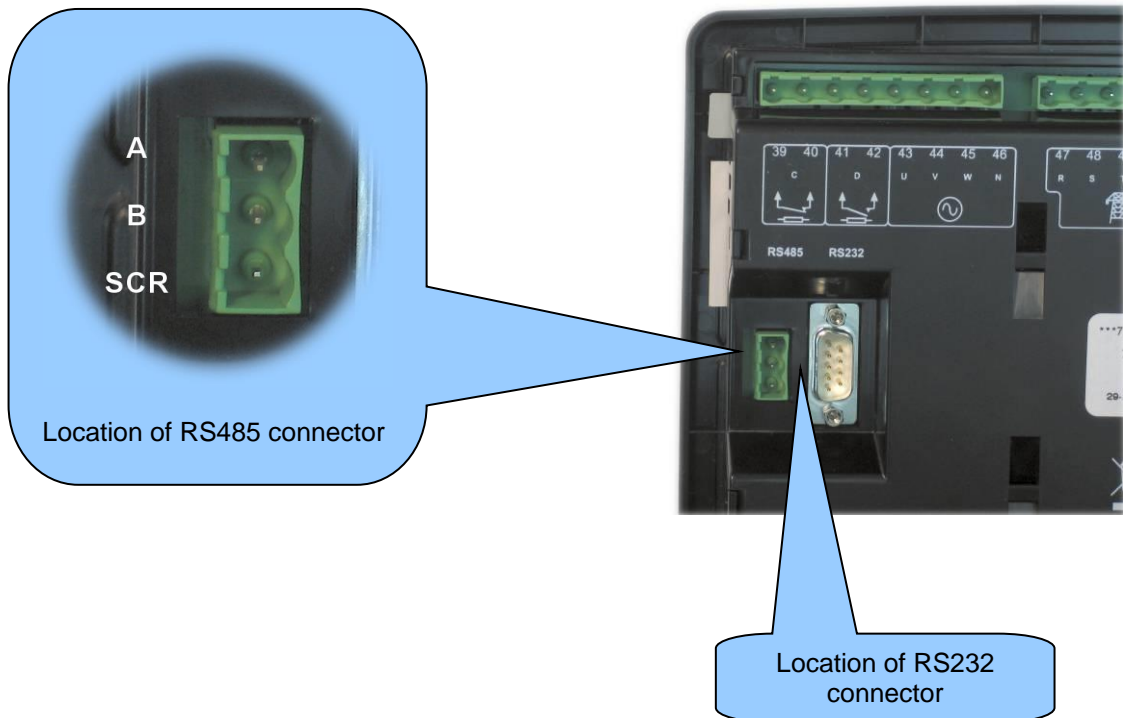

4.2 TYPICAL WIRING DIAGRAM

As every system has different requirements, these diagrams show only a TYPICAL system and do not intend to show a complete system.

Genset manufacturers and panel builders may use these diagrams as a starting point; however, you are referred to the completed system diagram provided by your system manufacturer for complete wiring detail.

Further wiring suggestions are available in the following DSE publications, available at www.deepseapl.com to website members.

DSE Part	Description
056-022	Breaker Control (Training guide)
057-004	Electronic Engines and DSE Wiring

NOTE: Connection for an AVR on terminals 37 and 38 are only available on module's version 2 and upwards.

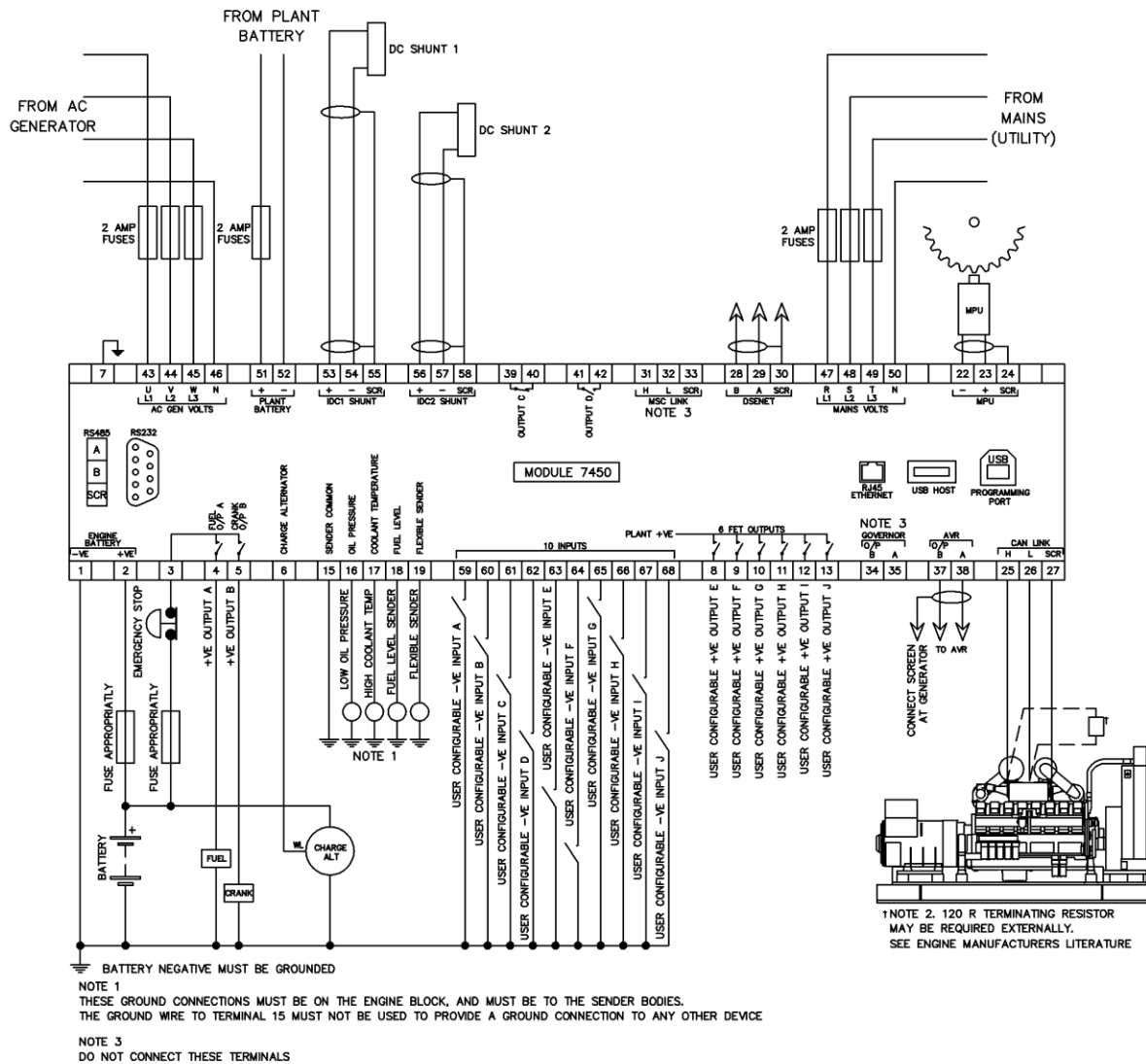

4.3 TYPICAL SINGLE LINE DIAGRAMS

4.3.1 WITH MAINS SENSING

4.3.1.1 AC GENERATOR AND RECTIFIER WITH A COMMON DC BUS

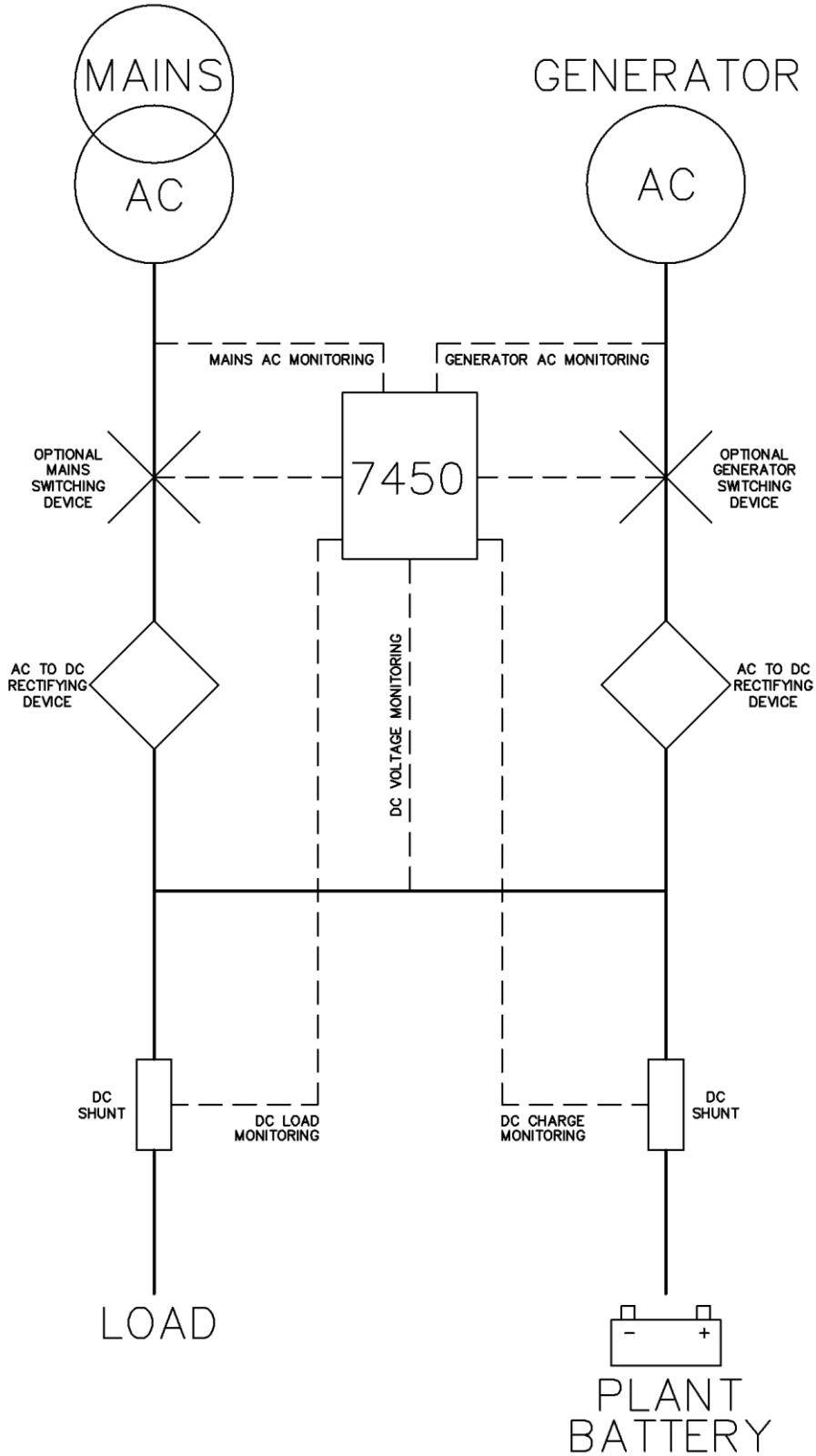

4.3.1.2 AC GENERATOR AND RECTIFIER WITH A COMMON AC & DC BUS

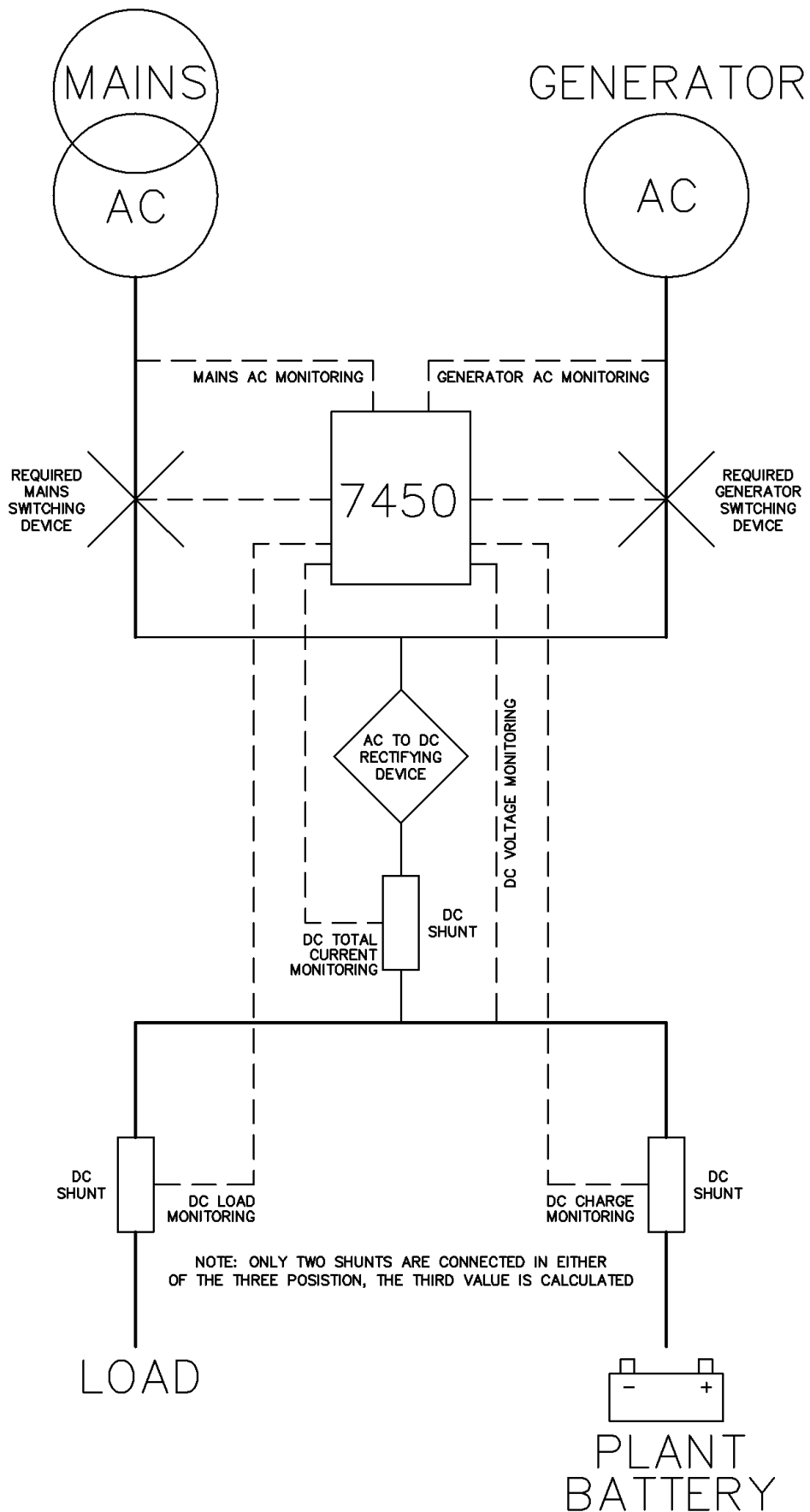

4.3.1.3 DC GENERATOR WITH A COMMON DC BUS

NOTE: Generator AC sensing is required to be disabled for this application. Refer to DSE7450 PC Configuration Suite Manual (DSE part 057-169) for further details on configuring, monitoring and control.

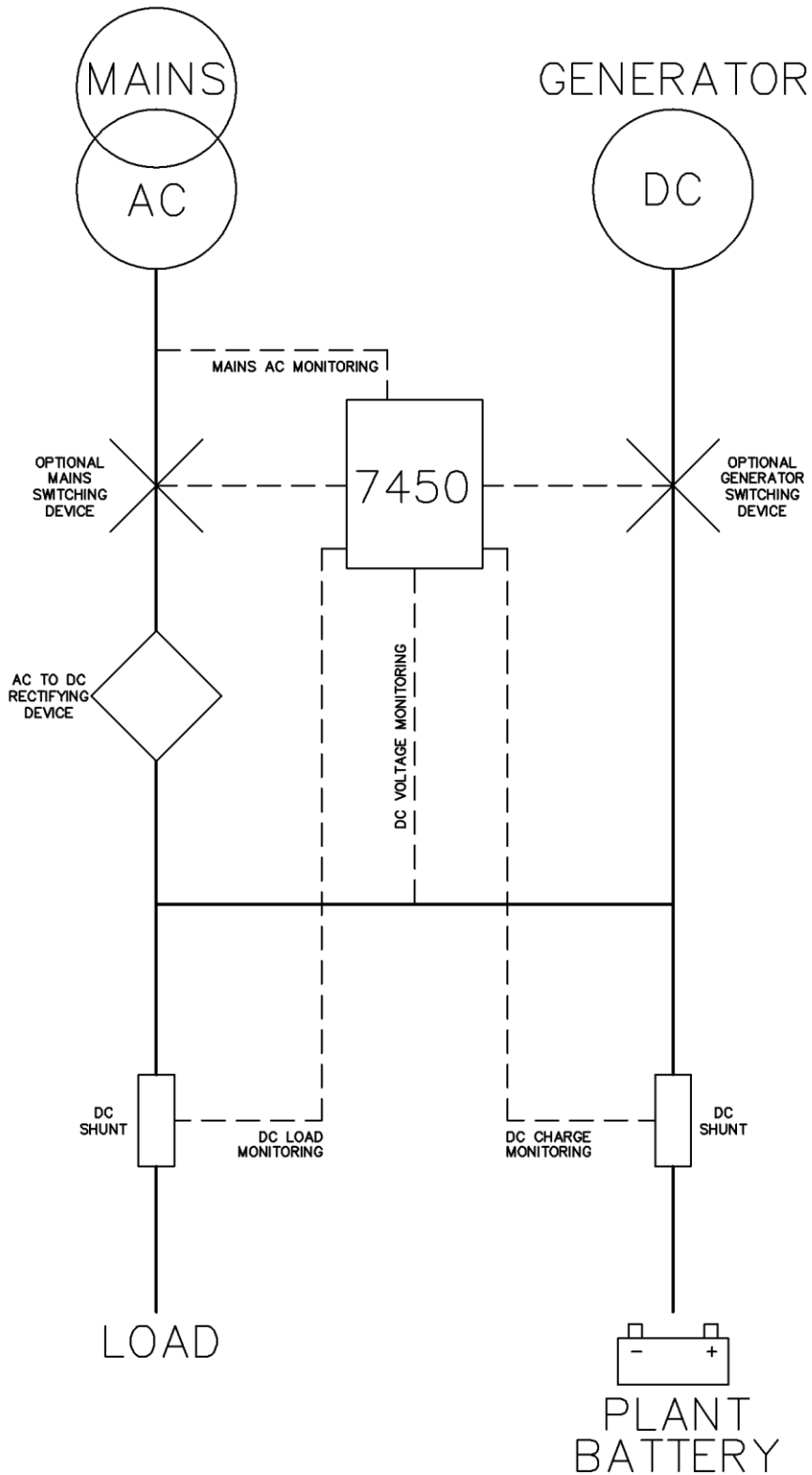

4.3.2 WITHOUT MAINS SENSING

4.3.2.1 AC GENERATOR WITH EXTERNAL RECTIFIER

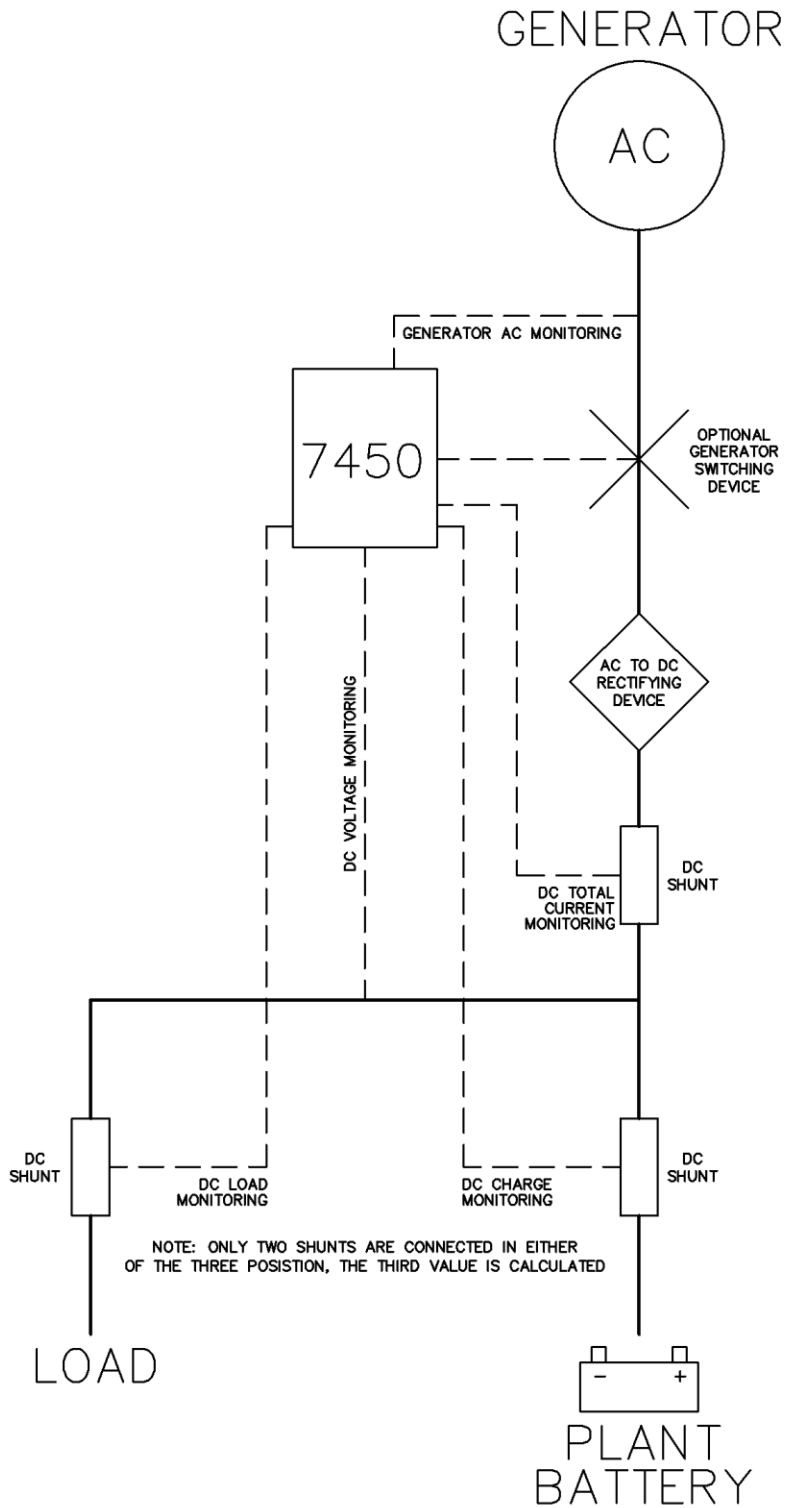

4.3.2.2 DC GENERATOR

NOTE: Generator AC sensing is required to be disabled for this application. Refer to DSE7450 PC Configuration Suite Manual (DSE part 057-169) for further details on configuring, monitoring and control.

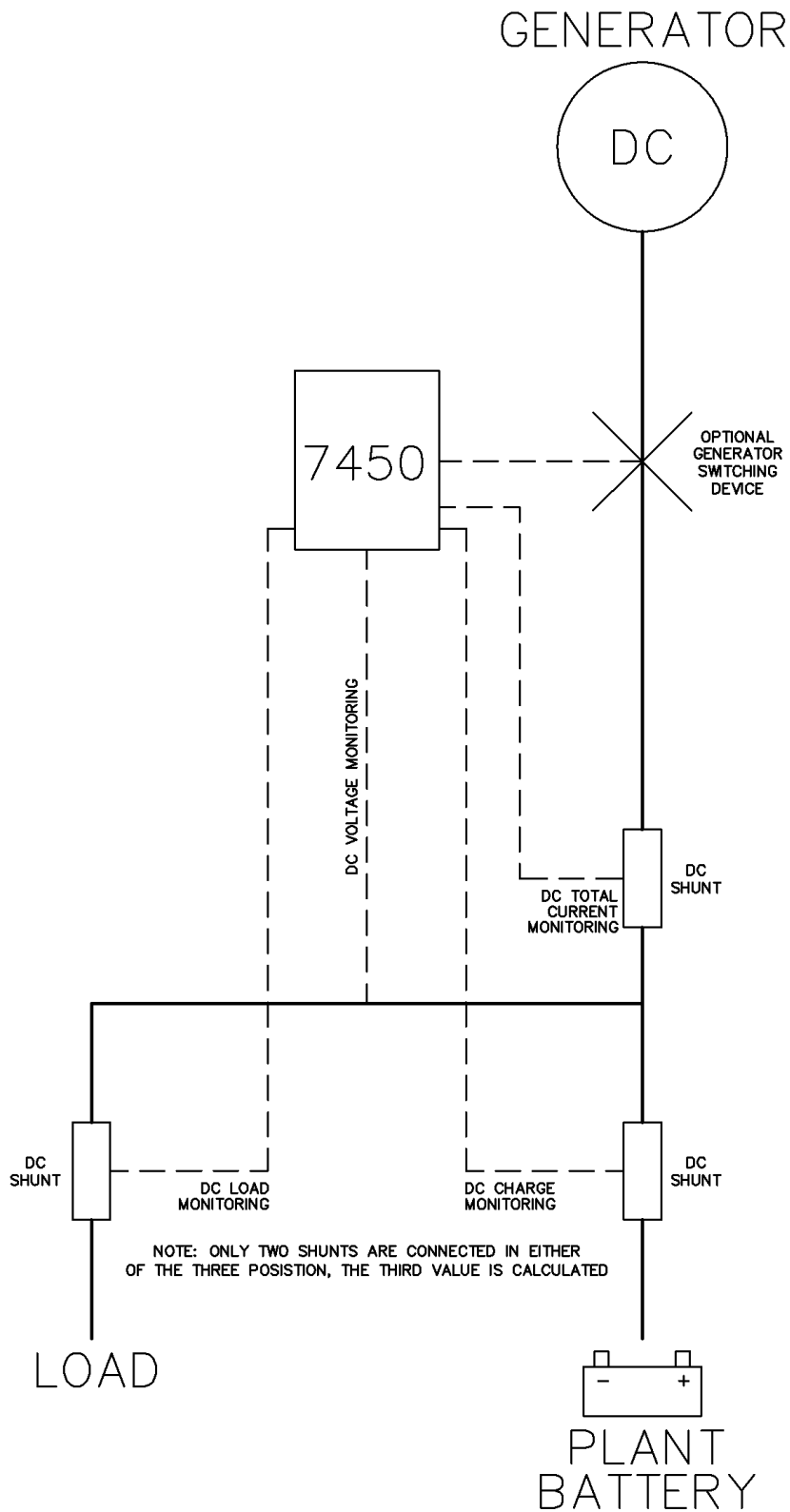

4.4 EARTH SYSTEMS

4.4.1 NEGATIVE EARTH

The typical wiring diagrams located within this document show connections for a negative earth system (the battery negative connects to Earth)

4.4.2 POSITIVE EARTH

When using a DSE module with a Positive Earth System (the battery positive connects to Earth), the following points must be followed:

- Follow the typical wiring diagram as normal for all sections EXCEPT the earth points
- All points shown as Earth on the typical wiring diagram should connect to BATTERY NEGATIVE (not earth).

4.4.3 FLOATING EARTH

Where neither the battery positive nor battery negative terminals are connected to earth the following points must be followed

- Follow the typical wiring diagram as normal for all sections EXCEPT the earth points
- All points shown as Earth on the typical wiring diagram should connect to BATTERY NEGATIVE (not earth).

4.5 TYPICAL ARRANGEMENT OF DSENET®

Twenty (20) devices can be connected to the DSENet®, made up of the following devices :

Device	Max Number Supported
DSE2130 Input Expansion	4
DSE2131 Ratio-metric Input Expansion	4
DSE2133 RTD/Thermocouple Input Expansion	4
DSE2152 Ratio-metric Output Expansion	4
DSE2157 Relay Output Expansion	10
DSE2548 LED Expansion	10

For part numbers of the expansion modules and their documentation, see section entitled *DSENet Expansion Modules* elsewhere in this manual.

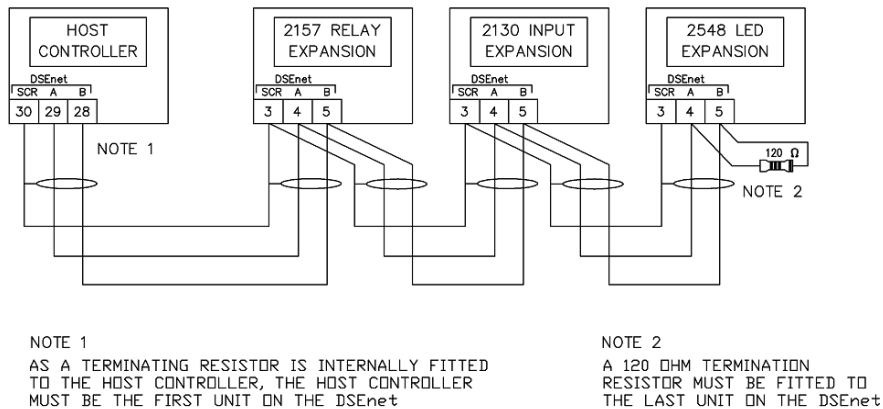

5 DESCRIPTION OF CONTROLS

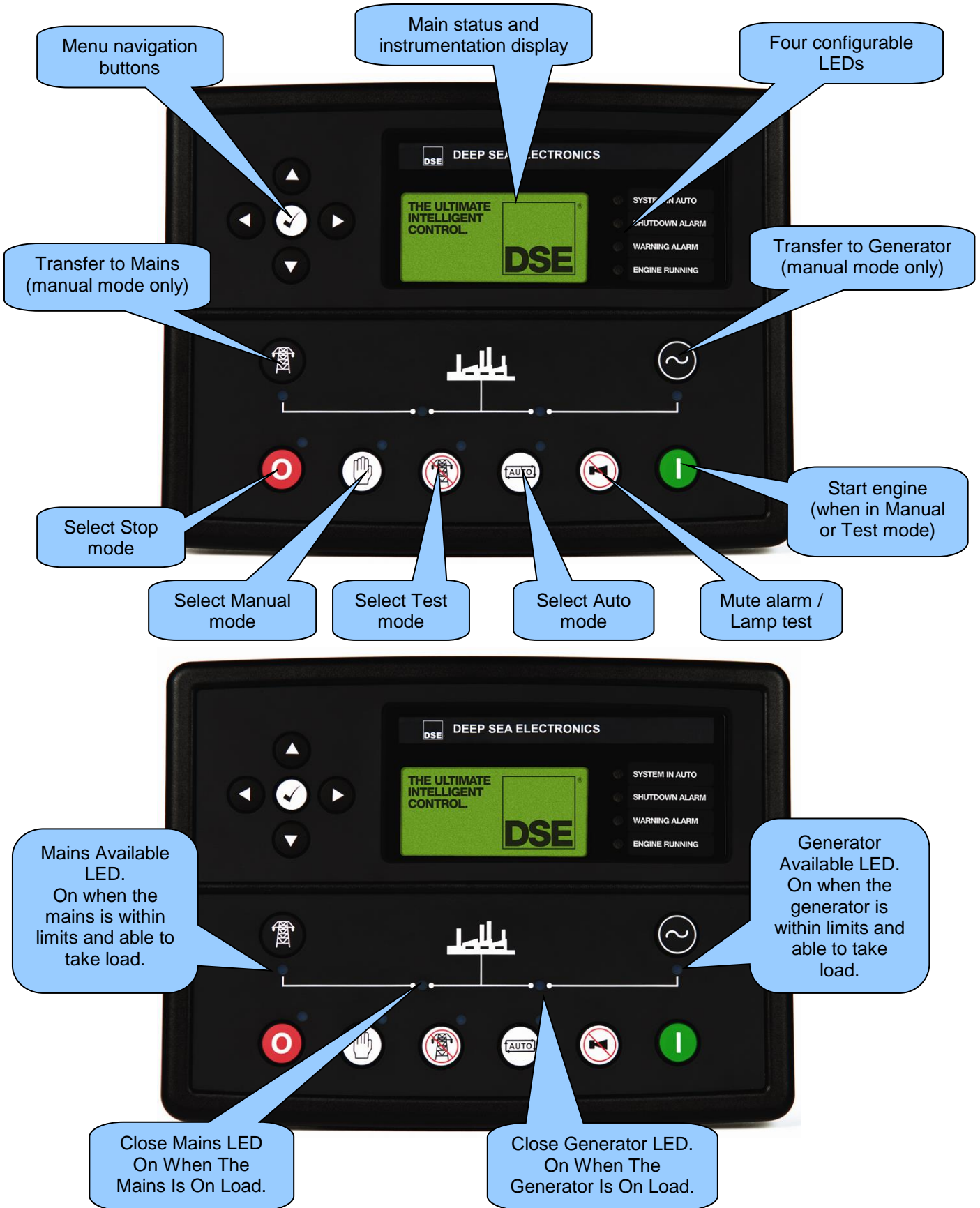

5.1 QUICKSTART GUIDE

This section provides a quick start guide to the module's operation.

5.1.1 STARTING THE ENGINE



NOTE: For further details, see the section entitled 'OPERATION' elsewhere in this manual.

5.1.2 STOPPING THE ENGINE



NOTE: For further details, see the section entitled 'OPERATION' elsewhere in this manual.

5.2 VIEWING THE INSTRUMENT PAGES

It is possible to scroll to display the different pages of information by repeatedly operating the next /

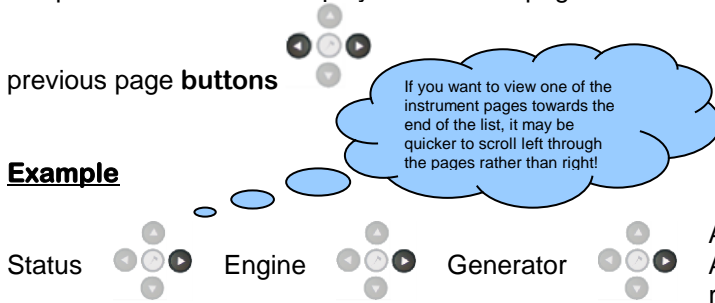

And so on until the last page is reached. A Further press of the scroll right button returns the display to the Status page.

The complete order and contents of each information page are given in the following sections

Once selected the page will remain on the LCD display until the user selects a different page, or after an extended period of inactivity (*LCD Page Timer*), the module will revert to the status display.

If no buttons are pressed upon entering an instrumentation page, the instruments will be displayed automatically subject to the setting of the *LCD Scroll Timer*.

The *LCD Page* and *LCD Scroll* timers are configurable using the DSE Configuration Suite Software or by using the Front Panel Editor.

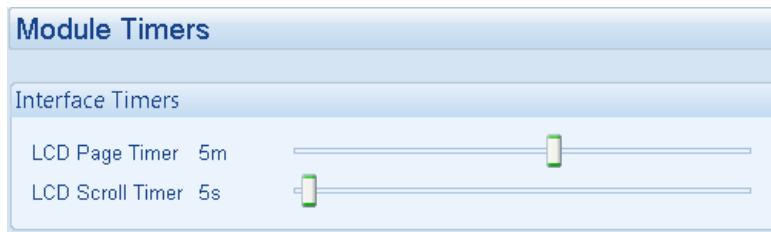

The screenshot shows the factory settings for the timers, taken from the DSE Configuration Suite Software.

Alternatively, to scroll manually through all instruments on the currently selected page, press the scroll

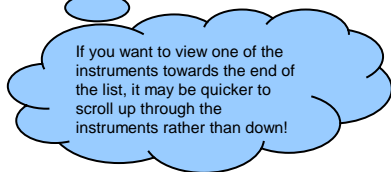
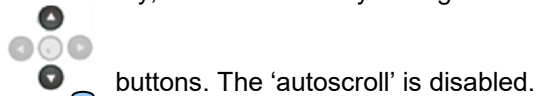

To re-enable 'autoscroll' press the scroll buttons to scroll to the 'title' of the instrumentation page (ie Engine). A short time later (the duration of the *LCD Scroll Timer*), the instrumentation display will begin to autoscroll.

When scrolling manually, the display will automatically return to the Status page if no buttons are pressed for the duration of the configurable *LCD Page Timer*.

If an alarm becomes active while viewing the status page, the display shows the Alarms page to draw the operator's attention to the alarm condition.

5.2.1 STATUS

This is the 'home' page, the page that is displayed when no other page has been selected, and the page that is automatically displayed after a period of inactivity (*LCD Page Timer*) of the module control buttons.

This page will change with the action of the controller, when the generator is on load, generator parameters will be seen and when changing to mains, the mains parameters will be shown.

Status	22:31	Factory setting of Status screen showing engine stopped...
Generator at Rest		
Battery Discharge		
Stop Mode		

Safety on Delay	00:04	...and engine running
L-N	215V	50.0Hz
L-L	373V	2.0A
DC	48V	10.0kW

The contents of this display may vary depending upon configuration by the generator manufacturer / supplier.

The display above is achieved with the factory settings, shown below in the DSE Configuration suite software:

Configurable Status Screens

Home Page

Home Page Mode

Displayed Pages

Page 1	Summary screen	Page 6	Not Used
Page 2	Not Used	Page 7	Not Used
Page 3	Not Used	Page 8	Not Used
Page 4	Not Used	Page 9	Not Used
Page 5	Not Used	Page 10	Not Used

'Stop Mode' etc is displayed on the Home Page

With a summary of the instrumentation shown when the engine is running.

Other pages can be configured to be shown, automatically scrolling when the set is running.

NOTE: The following sections detail instrumentation pages, accessible using the scroll left and right buttons, regardless of what pages are configured to be displayed on the 'status' screen.

5.2.2 ENGINE

Contains instrumentation gathered about the engine itself, some of which may be obtained using the CAN or other electronic engine link.

- Engine Speed
- Oil Pressure
- Coolant Temperature
- Engine Battery Volts
- Engine Run Time
- Engine Fuel Level
- Oil Temperature*
- Coolant Pressure*
- Inlet Temperature*
- Exhaust Temperature*
- Fuel Temperature*
- Turbo Pressure*
- Fuel Pressure*
- Fuel Consumption*
- Fuel Used*
- Fuel Level*
- Auxiliary Sensors (If fitted and configured)
- Engine Maintenance Due (If configured)
- Engine ECU Link*

*When connected to suitably configured and compatible engine ECU. For details of supported engines see 'Electronic Engines and DSE wiring' (DSE Part number 057-004).

- Tier 4 engine information will also be available if used with a Tier 4 suitable engine / ECU.

Depending upon configuration and instrument function, some of the instrumentation items may include a tick  icon beside them. This denotes a further function is available, detailed in the 'operation' section of this document.

Example:

The tick  icon denotes that manual fuel pump control is enabled in this system. Press and hold to start the fuel transfer pump, release to stop the pump. This is detailed further in the section entitled 'operation' elsewhere in this document.

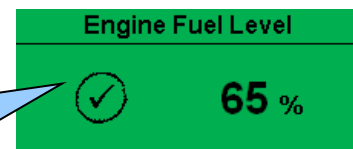

5.2.3 GENERATOR

Contains electrical values of the generator AC alternator, measured from the module's AC voltage inputs.

- Generator Voltage (ph-N)
- Generator Voltage (ph-ph)
- Generator Frequency
- Generator Phase Sequence
- Generator Active Config
- AVR Bias Voltage

5.2.4 MAINS

Contains electrical values of the Mains AC supply, measured from the module's AC voltage inputs.

- Mains Voltage (ph-N)
- Mains Voltage (ph-ph)
- Mains Frequency
- Mains Phase Sequence
- Mains Active Config

5.2.5 DC

Contains electrical values of the DC supply, measured and derived from the module's voltage and shunt inputs.

- DC Voltage
- DC Current (Load, Battery & Charger)
- DC Power (Load kW, Battery kW & Charger kW)
- DC Power (Total kW and Total %)
- DC Power (Charging kWh and Discharging kWh)
- DC Power (Generator kWh and Mains kWh)
- DC Power (Load kWh and Total kWh)

5.2.6 PLANT BATTERY

Contains information for the Plant Battery supply, measured and derived from the module's DC voltage and shunt inputs.

- Plant Battery Run Time
- Plant Battery Cycles
- Plant Battery Charge State (%)
- Plant Battery Discharge State (%)
- Plant Battery Charge Mode (Discharged, Discharging, Charging or Floating)
- Plant Battery Temperature
- Plant Battery (Battery Capacity (Ah) and Battery Current (A))

5.2.7 EVENT LOG

The module maintains a log of past alarms and/or selected status changes. The log size has been increased in the module over past module updates and is always subject to change. At the time of writing, the modules log is capable of storing the last 250 log entries.

Under default factory settings, the event log only includes shutdown and electrical trip alarms logged (The event log does not contain Warning alarms); however, this is configurable by the system designer using the DSE Configuration Suite software.



Example showing the possible configuration of the modules event log (DSE Configuration Suite Software) This also shows the factory settings of the module (Only shutdown alarms and the mains status are logged).

Once the log is full, any subsequent shutdown alarms will overwrite the oldest entry in the log. Hence, the log will always contain the most recent shutdown alarms. The module logs the alarm, along with the date and time of the event (or engine running hours if configured to do so). If the module is configured and connected to send SMS text

To view the event log, repeatedly press the next page button  until the LCD screen displays the Event log :

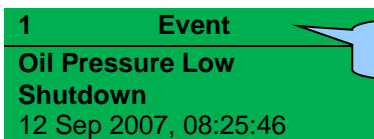

This is event 1.

Press down  to view the next most recent shutdown alarm:

Continuing to press down  cycles through the past alarms after which the display shows the most recent alarm and the cycle begins again.

To exit the event log and return to viewing the instruments, press the next page  button to select the next instrumentation page.

5.2.8 ALARMS

When an alarm is present, the Audible Alarm will sound and the Common alarm LED if configured will illuminate.

The audible alarm can be silenced by pressing the *Mute button* 

The LCD display will jump from the 'Information page' to display the Alarm Page

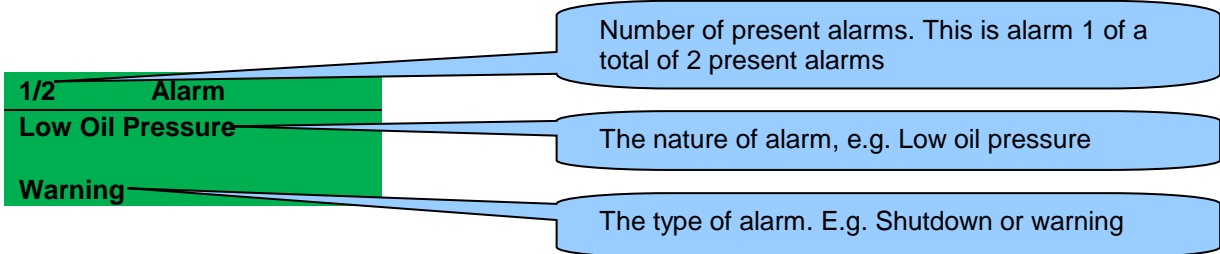

The LCD will display multiple alarms E.g. "High Engine Temperature shutdown", "Emergency Stop" and "Low Coolant Warning". These will automatically scroll in the order that they occurred.

In the event of a warning alarm, the LCD will display the appropriate text. If a shutdown then occurs, the module will again display the appropriate text.
Example:-



5.2.8.1 CAN ERROR MESSAGES

When connected to a suitable CAN engine the controller displays alarm status messages from the ECU.

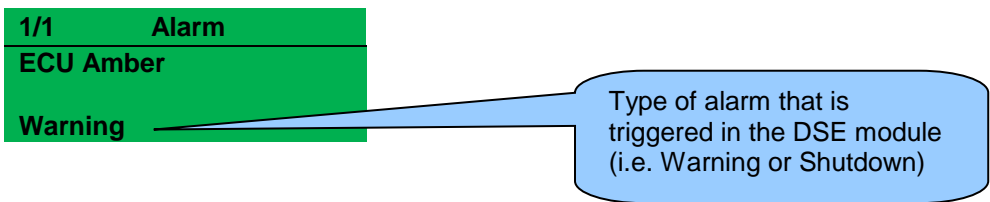

Press  to access the list of current active Engine DTCs (Diagnostic Trouble Codes).

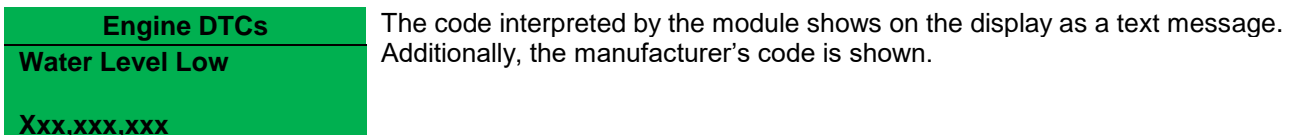

NOTE: For details on these code meanings, refer to the ECU instructions provided by the engine manufacturer, or contact the engine manufacturer for further assistance.

NOTE: For further details on connection to electronic engines please refer to *Electronic engines and DSE wiring*. Part No. 057-004

5.2.9 SERIAL PORT

5.2.9.1 RS232 SERIAL PORT

This section is included to give information about the RS232 serial port and external modem (if connected).

The items displayed on this page will change depending upon configuration of the module. You are referred to your system supplier for further details.

NOTE: Factory Default settings are for the RS232 port to be enabled with no modem connected, operating at 19200 baud, Modbus slave address 10.

Module connected to an RS232 telephone modem

When the module is powered up, it will send 'initialisation strings' to the connected modem. It is important therefore that the modem is already powered, or is powered up at the same time as the module. At regular intervals after power up, the modem is reset, and reinitialised, to ensure the modem does not 'hang up'.

If the module does not correctly communicate with the modem, "Modem initialising" appears on the Serial Port instrument screen as shown overleaf.

If the module is set for "incoming calls" or for "incoming and outgoing calls", then if the modem is dialled, it will answer after two rings (using the factory setting 'initialisation strings'). Once the call is established, all data is passed from the dialling PC and the module.

If the module is set for "outgoing calls" or for "incoming and outgoing calls", then the module will dial out whenever an alarm is generated. Note that not all alarms will generate a dial out; this is dependant upon module configuration of the event log. Any item configured to appear in the event log will cause a dial out.

Serial Port	
Baud	9600
SlaveID	10
Modem	



Press down  to view the modem status....

Indicates that a modem is configured. Shows 'RS232' if no modem is configured.

Example 1 continued – Modem diagnostics



Modem diagnostic screens are included; press  when viewing the *RS232 Serial Port* instrument to cycle the available screens. If you are experiencing modem communication problems, this information will aid troubleshooting.

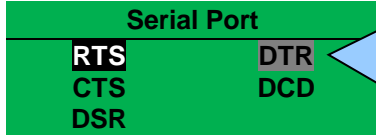

Shows the state of the modem communication lines. These can help diagnose connection problems.

Example:

RTS A dark background shows the line is active.

RTS a grey background shows that the line is toggling high and low.

RTS No background indicates that the line is inactive

Line	Description	
RTS	Request to Send	Flow Control
CTS	Clear to Send	Flow Control
DSR	Data Set Ready	Ready to Communicate
DTR	Data Terminal Ready	Ready to Communicate
DCD	Data Carrier Detect	Modem is Connected

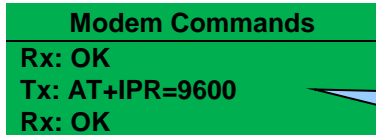

Shows the last command sent to the modem and the result of the command.

Modem Setup Sequence

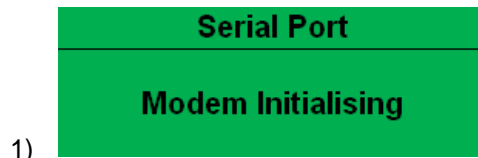

If the Modem and module communicate successfully:

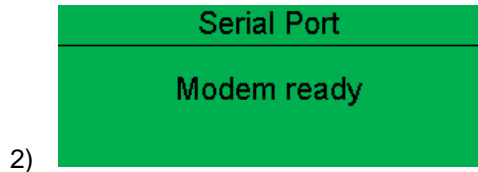

In case of communication failure between the modem and module, the modem is automatically reset and initialisation is attempted once more:

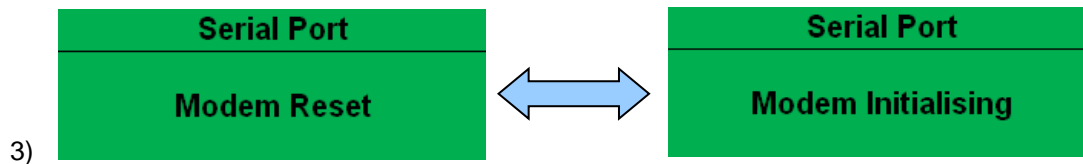

In the case of a module that is unable to communicate with the modem, the display will continuously cycle between 'Modem Reset' and 'Modem Initialising' as the module resets the modem and attempts to communicate with it again, this will continue until correct communication is established with the modem.

In this instance, you should check connections and verify the modem operation.

Example 2 – Module connected to a modem.

Serial Port	
Baud	9600
SlaveID	10
Modem	

Example 3 – Modem status of a GSM modem

Currently connected GSM operator and signal strength.

Serial Port
Orange Modem Ready

Many GSM modems are fitted with a status LED to show operator cell status and ringing indicator. These can be a useful troubleshooting tool.

In the case of GSM connection problems, try calling the DATA number of the SIMCARD with an ordinary telephone. There should be two rings, followed by the modem answering the call and then 'squealing'. If this does not happen, you should check all modem connections and double check with the SIM provider that it is a DATA SIM and can operate as a data modem. DATA is NOT the same as FAX or GPRS and is often called Circuit Switched Data (CSD) by the SIM provider.

▲NOTE: In the case of GSM modems, it is important that a DATA ENABLED SIM is used. This is often a different number than the 'voice number' and is often called Circuit Switched Data (CSD) by the SIM provider.

If the GSM modem is not purchased from DSE, ensure that it has been correctly set to operate at 9600 baud.

5.2.9.2 RS485 SERIAL PORT

This section is included to give information about the currently selected serial port and external modem (if connected).

The items displayed on this page will change depending upon configuration of the module. You are referred to your system supplier for further details.

NOTE: Factory Default settings are for the RS485 port to operating at 19200 baud, modbus slave address 10.

Module RS485 port configured for connection to a modbus master.

The modules operate as a modbus RTU slave device. In a modbus system, there can be only one Master, typically a PLC, HMI system or PC SCADA system.

Serial Port	
Baud	19200
SlaveID	1
RS485	

This master requests for information from the modbus slave (The module) and may (in control systems) also send request to change operating modes etc. Unless the Master makes a request, the slave is 'quiet' on the data link.

The factory settings are for the module to communicate at 19200 baud, modbus slave address 10.

To use the RS485 port, ensure that 'port usage' is correctly set using the DSE Configuration Suite Software. Required settings are shown below.

'Master inactivity timeout' should be set to at least twice the value of the system scan time. For example if a modbus master PLC requests data from the module once per second, the timeout should be set to at least 2 seconds.

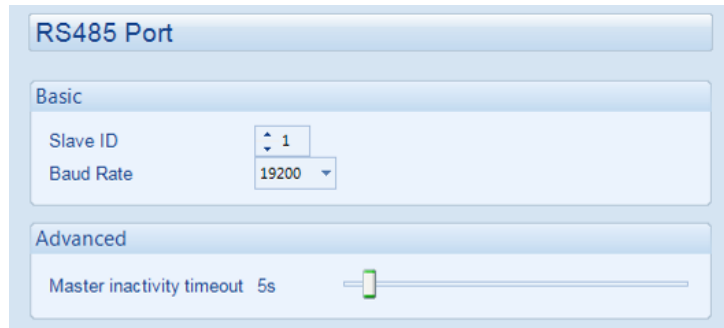

The DSE Modbus Gencomm document containing register mappings inside the DSE module is available upon request from support@deepseapl.com. Email your request along with the serial number of your DSE module to ensure the correct information is sent to you.

Typical requests (using Pseudo code)

BatteryVoltage=ReadRegister(10,0405,1) : reads register (hex) 0405 as a single register (battery volts) from slave address 10.

WriteRegister(10,1008,2,35701, 65535-35701) : Puts the module into AUTO mode by writing to (hex) register 1008, the values 35701 (auto mode) and register 1009 the value 65535-35701 (the bitwise opposite of auto mode)

Shutdown=(ReadRegister(10,0306,1) >> 12) & 1) : reads (hex) 0306 and looks at bit 13 (shutdown alarm present)

Warning=(ReadRegister(10,0306,1) >> 11) & 1) : reads (hex) 0306 and looks at bit 12 (Warning alarm present)

ElectricalTrip=(ReadRegister(10,0306,1) >> 10) & 1) : reads (hex) 0306 and looks at bit 11 (Electrical Trip alarm present)

ControlMode=ReadRegister(10,0304,2); reads (hex) register 0304 (control mode).

5.2.10 ABOUT

5.2.10.1 MODULE INFORMATION

Contains important information about the module and the firmware versions. This information may be asked for when contacting DSE Technical Support Department for advice.

About	
Variant	7450
Application	V1.0.36
USB ID	BC614E

- Variant (7410 or 7420)
- Application Version – The version of the module's main firmware file (Updatable using the Firmware Update Wizard in the DSE Configuration Suite Software).
- USB ID – Unique identifier for PC USB connection



Press  to access more information about the module.

About	
Bootloader	V1.3.4
Analogue	V1.0.4
Engine	V1.20

- Bootloader - Firmware Update bootloader software version
- Analogue – Analogue measurements software version
- Engine – Engine type file version.

5.2.10.2 ETHERNET PAGES

Whilst in the 'ABOUT' section, press  to access more information about the network settings. Network settings change be configured using DSE Configuration Suite Software. The module must be rebooted for the changes to take effect.

Network	
IP Address	192.168.50.76
DHCP	Disabled

- IP Address – The configured network IP address of the module
- DHCP – Dynamic Host Configuration Protocol (DHCP) has been enabled or disabled in the modules configuration.

Press  to access more information about the network settings.

Network	
Subnet Mask	255.255.255.0

- Subnet Mask – The configured network subnet mask of the module.

Network	
Gateway Address	192.168.49.76

- Gateway Address – The configured network gateway address of the module.

Network	
DNS Address	192.168.88.99

- DNS Address – The configured network DNS address of the module.

Network	
MAC Address	E8.A4.C1.0.A.C2

- MAC Address – The MAC address of the module, this cannot be changed and is unique to each module.

DHCP	
Host Domain Vender	

- DHCP – The DHCP settings of module if configured.

MODBUS Over IP	
TCP Port	502
Pref IP	192.168.20.11

- TCP Port – The MODBUS TCP communication port number.
- Pref IP – The preferred IP address.

5.2.10.3 DATA LOGGING PAGES

Whilst in the 'ABOUT' section, press  to access more information about the data logging settings.

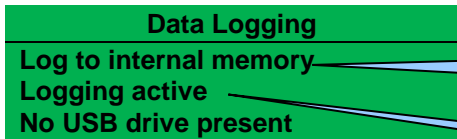



Location of stored data.
Internal module memory or external USB memory.

If data logging is active or inactive

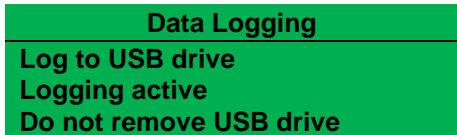
Inserting a USB drive to the host USB will display the following change to the page.



 **NOTE: Removal of the USB drive should only be carried out using the following method.**

Press and hold the  tick button until "Ok to remove USB drive" is displayed.

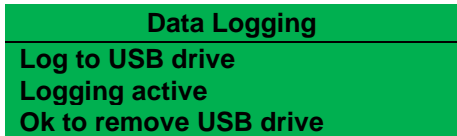

It is now safe to remove the USB drive.
This ensures the logging data file will save to memory complete and will not become corrupt.

Press down  to view the next page.

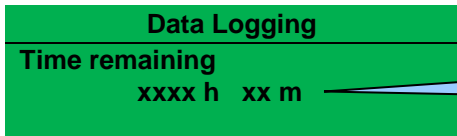

Remaining time available for logging information.
xxxx hours xx minutes

Press down  to view the next page.

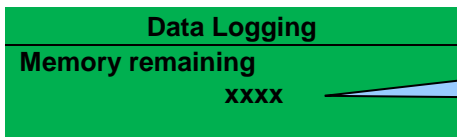

Memory space remaining, this depends what size memory drive is fitted (Max 16Gb) or allocated internal (2Mb) memory left available.

5.3 USER CONFIGURABLE INDICATORS

These LEDs can be configured by the user to indicate any one of **100+ different functions** based around the following:-

- **Indications** - Monitoring of a digital input and indicating associated functioning user's equipment - *Such as Battery Charger On or Louvres Open, etc.*
- **Warnings, Electrical Trips & Shutdowns Alarms** - Specific indication of a particular warning or shutdown condition, backed up by LCD indication - *Such as Low Oil Pressure Shutdown, Low Coolant level, etc.*
- **Status Indications** - Indication of specific functions or sequences derived from the modules operating state - *Such as Safety On, Pre-heating, Panel Locked, Generator Available, etc.*

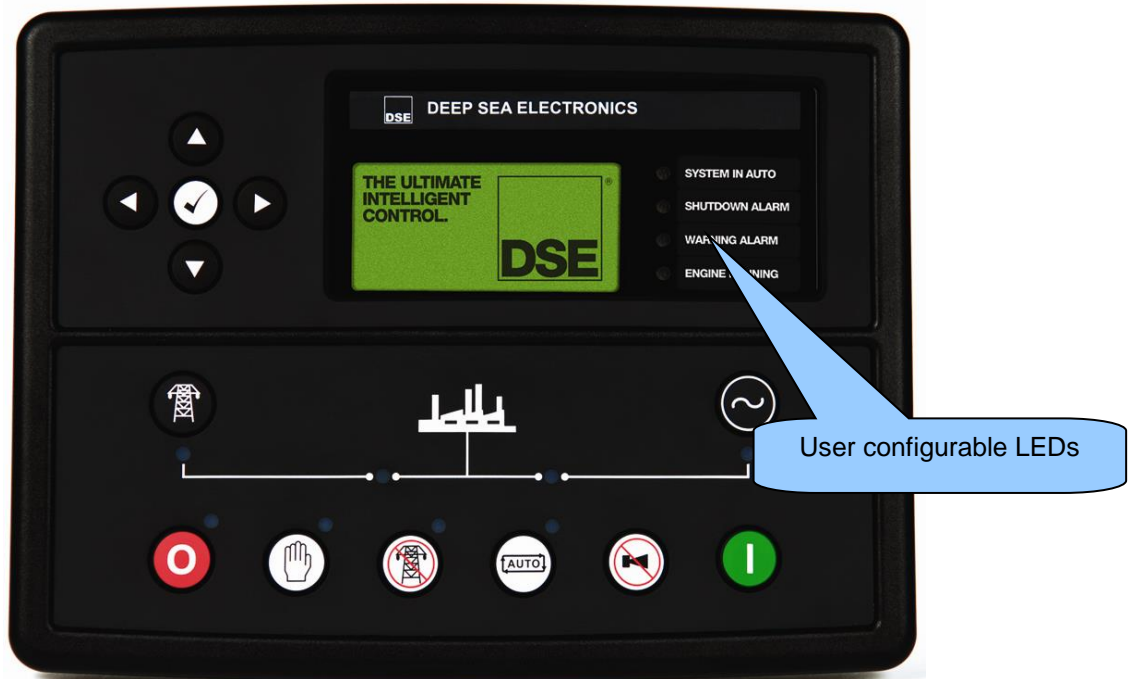

6 OPERATION

6.1 CONTROL

Control of the module is via push buttons mounted on the front of the module with **STOP/RESET**, **MANUAL**, **TEST**, **AUTO**, **ALARM MUTE** and **START** functions. For normal operation, these are the only controls which need to be operated. The smaller push buttons are used to access further information such as mains voltage or to change the state of the load switching devices when in manual mode. Details of their operation are provided later in this document.





















NOTE: The following descriptions detail the sequences followed by a module containing the standard 'factory configuration'. Always refer to your configuration source for the exact sequences and timers observed by any particular module in the field.





CAUTION: The module may instruct an engine start event due to external influences. Therefore, it is possible for the engine to start at any time without warning. Prior to performing any maintenance on the system, it is recommended that steps are taken to remove the battery and isolate supplies.

NOTE: This control module has PLC functionality built in. This can have change the standard operation when used. (Default configuration the no PLC is set. See software manual for more information)

6.2 CONTROL PUSH-BUTTONS

<p>Stop / Reset</p> <p>This button places the module into its Stop/Reset  mode. This will clear any alarm conditions for which the triggering criteria have been removed. If the engine is running and the module is in Stop mode, the module will automatically instruct the changeover device to unload the generator ('Close Generator' becomes inactive (if used)). The fuel supply de-energises and the engine comes to a standstill. Should a remote start signal be present while operating in this mode, a remote start will <u>not</u> occur.</p>	
<p>Manual</p> <p>This mode allows manual control of the generator functions. Once in Manual  mode the module will respond to the start  button, start the engine, and run off load. If the engine is running off-load in the Manual  mode and a remote start signal becomes present, the module will automatically instruct the changeover device to place the generator on load ('Close Generator' becomes active (if used)). Upon removal of the remote start signal, the generator remains on load until either selection of the 'STOP/RESET  or 'AUTO , modes.</p> <p><i>For further details, please see the more detailed description of 'Manual operation' elsewhere in this manual.</i></p>	
<p>Test</p> <p>This button places the module into its 'Test'  mode. This allows an on load test of the generator.</p> <p>Once in Test  mode the module will respond to the start  button, start the engine, and run on load.</p> <p><i>For further details, please see the more detailed description of 'Test operation' elsewhere in this manual.</i></p>	
<p>Auto</p> <p>This button places the module into its 'Automatic' mode. This mode allows the module to control the function of the generator automatically. The module will monitor the <i>remote start</i> input, mains supply and battery charge status and once a start request is made, the set will be automatically started and placed on load. Upon removal of the starting signal, the module will automatically transfer the load from the generator and shut the set down observing the <i>stop delay</i> timer and <i>cooling</i> timer as necessary. The module will then await the next start event.</p> <p><i>For further details, please see the more detailed description of 'Auto operation' elsewhere in this manual.</i></p>	
<p>Mute / Lamp Test</p> <p>This button silences the audible alarm if it is sounding and illuminates all of the LEDs as a lamp test feature/</p> <p>When correctly configured and fitted to a compatible engine ECU, pressing this button in STOP/RESET  mode after pressing the START  button (to power the ECU) will cancel any "passive" alarms on the engine ECU.</p>	
<p>Start</p> <p>This button is only active in STOP/RESET  or MANUAL  mode.</p> <p>Pressing this button in manual or test mode will start the engine and run off load (manual) or on load (test).</p> <p>Pressing this button in STOP/RESET  mode will turn on the CAN engine ECU (when correctly configured and fitted to a compatible engine ECU)</p>	

<p>Transfer to Generator Operative in Manual Mode only</p> <p>'Normal' breaker button control</p> <ul style="list-style-type: none"> • Allows the operator to transfer the load to the generator <p>'Alternative' breaker button control</p> <ul style="list-style-type: none"> • If mains is on load, transfers the load to the generator. • If generator is on load, opens the generator breaker • If generator and mains are off load, closes the generator breaker. 	
<p>Transfer to Mains Operative in Manual Mode only</p> <p>'Normal' breaker button control</p> <ul style="list-style-type: none"> • Allows the operator to transfer the load to the mains <p>'Alternative' breaker button control</p> <ul style="list-style-type: none"> • If generator is on load, transfers the load to the mains. • If mains is on load, opens the mains breaker • If generator and mains are off load, closes the mains breaker. 	
<p>Menu Navigation</p> <p>Used for navigating the instrumentation, event log and configuration screens. For further details, please see the more detailed description of these items elsewhere in this manual.</p>	

6.3 STOP MODE

▲NOTE: If a digital input configured to *panel lock* is active, changing module modes will not be possible. Viewing the instruments and event logs is NOT affected by panel lock.

STOP mode is activated by pressing the  button.



In STOP  mode, the module will remove the generator from load (if necessary) before stopping the engine if it is already running.



If the engine does not stop when requested, the FAIL TO STOP alarm is activated (subject to the setting of the *Fail to Stop* timer). To detect the engine at rest the following must occur :

- Engine speed is zero as detected by the Magnetic Pickup or CANbus ECU (depending upon module variant).
- Generator AC Voltage and Frequency must be zero.
- Engine Charge Alternator Voltage must be zero.
- Oil pressure switch must be closed to indicate low oil pressure

When the engine has stopped, it is possible to send configuration files to the module from DSE Configuration Suite PC software and to enter the Front Panel Editor to change parameters.

Any latched alarms that have been cleared will be reset when STOP  mode is entered.

The engine will not be started when in STOP  mode. If remote start signals are given, the input is ignored until AUTO  mode is entered.

When configured to do so, when left in STOP  mode for five minutes with no presses of the fascia buttons or remote communication activity, the module enters low power mode. To 'wake' the module, press the  button or any other fascia control button.

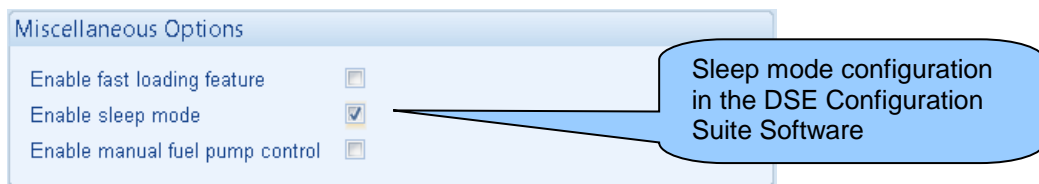



6.3.1 ECU OVERRIDE

 **NOTE: ECU Override function is only applicable when the controller is configured for a CAN engine.**

 **NOTE: Depending upon system design, the ECU may be powered or unpowered when the module is in STOP mode. ECU override is only applicable if the ECU is unpowered when in STOP mode.**

When the ECU powered down (as is normal when in STOP mode), it is not possible to read the diagnostic trouble codes or instrumentation. Additionally, it is not possible to use the engine manufacturers' configuration tools.

As the ECU is usually unpowered when the engine is not running, it must be turned on manually as follows :

- Select STOP  mode on the DSE controller.
- Press and hold the START  button to power the ECU. As the controller is in STOP mode, the engine will not be started.
- The ECU will remain powered 2 minutes after the START button is released.

This is also useful if the engine manufacturer's tools need to be connected to the engine, for instance to configure the engine as the ECU needs to be powered up to perform this operation.

6.4 MANUAL MODE

 **NOTE: If a digital input configured to *panel lock* is active, changing module modes will not be possible. Viewing the instruments and event logs is NOT affected by panel lock.**

Activate Manual mode by pressing the  pushbutton. An LED indicator beside the button confirms this action.

Manual mode allows the operator to start and stop the set manually, and if required change the state of the load switching devices.

6.4.1 WAITING IN MANUAL MODE

When in manual mode, the set will not start automatically.

To begin the starting sequence, press the  button.

6.4.2 STARTING SEQUENCE

 **NOTE: There is no *start delay* in this mode of operation.**

The fuel relay is energised and the engine is cranked.

 **NOTE: If the unit has been configured for CAN, compatible ECU's will receive the start command via CAN.**

If the engine fails to fire during this cranking attempt then the starter motor is disengaged for the *crank rest* duration after which the next start attempt is made. Should this sequence continue beyond the set number of attempts, the start sequence will be terminated and the display shows ***Fail to Start***.

When the engine fires, the starter motor is disengaged. Speed detection is factory configured to be derived from the main alternator output frequency but can additionally be measured from a Magnetic Pickup mounted on the flywheel (Selected by the configuration software).

Additionally, rising oil pressure can be used to disconnect the starter motor (but cannot detect underspeed or overspeed).

 **NOTE: If the unit has been configured for CAN, speed sensing is via CAN.**

After the starter motor has disengaged, the *Safety On* timer activates, allowing Oil Pressure, High Engine Temperature, Under-speed, Charge Fail and any delayed Auxiliary fault inputs to stabilise without triggering the fault.

6.4.3 ENGINE RUNNING

In manual mode, the load is not transferred to the generator unless a 'loading request' is made. A loading request can come from a number of sources.

- Pressing the *transfer to generator*  button
- Mains supply out of limits
- Activation of an auxiliary input that has been configured to *remote start on load*
- Activation of low plant battery charge status (Please see section entitled: *Plant Battery Charging* else where in this manual for more details).
- Activation of the inbuilt exercise scheduler if configured for 'on load' runs.





NOTE: The load transfer signal remains inactive until the Oil Pressure has risen. This prevents excessive wear on the engine.

Once the load has been transferred to the generator, it will not be automatically transferred back to the mains supply. To manually transfer the load back to the mains either:

- Press the *Transfer to Mains*  button
- Press the *Auto Mode*  button to return to automatic mode.



For further details of breaker control, see the section entitled "controls and indications" elsewhere in this manual.

6.4.4 MANUAL FUEL PUMP CONTROL

- Navigate to the instruments page using the  buttons and locate FUEL LEVEL.  is shown on the module display to indicate that this feature is available.
- Press and hold the  button to energise the transfer pump. The pump starts two seconds after the button is pressed.
- Release the  button to de-energise the transfer pump.

6.4.5 STOPPING SEQUENCE

In manual mode the set will continue to run until either:

- The *stop button*  is pressed – The set will immediately stop
- The *auto button*  is pressed. The set will observe all auto mode start requests and stopping timers before beginning the *Auto mode stopping sequence*.

6.5 TEST MODE

 **NOTE: If a digital input configured to *panel lock* is active, changing module modes will not be possible. Viewing the instruments and event logs is NOT affected by panel lock.**

Activate test mode by pressing the  pushbutton. An LED indicator beside the button confirms this action.

Test mode will start the set and transfer the load to the generator to provide a ***Test on load*** function.

6.5.1 WAITING IN TEST MODE

When in test mode, the set will not start automatically.

To begin the starting sequence, press the  button.

6.5.2 STARTING SEQUENCE

The set begins to crank.

 **NOTE: If the unit has been configured for CAN, compatible ECU's will receive the start command via CAN.**

If the engine fails to fire during this cranking attempt then the starter motor is disengaged for the *crank rest* duration after which the next start attempt is made. Should this sequence continue beyond the set number of attempts, the start sequence will be terminated and the display shows ***Fail to Start***.

When the engine fires, the starter motor is disengaged. Speed detection is factory configured to be derived from the main alternator output frequency but can additionally be measured from a Magnetic Pickup mounted on the flywheel (Selected by PC using the configuration software).

Additionally, rising oil pressure can be used to disconnect the starter motor (but cannot detect underspeed or overspeed).

 **NOTE: If the unit has been configured for CAN, speed sensing is via CAN.**

After the starter motor has disengaged, the *Safety On* timer activates, allowing Oil Pressure, High Engine Temperature, Under-speed, Charge Fail and any delayed Auxiliary fault inputs to stabilise without triggering the fault.



6.5.3 ENGINE RUNNING

Once the engine is running, the *Warm Up* timer, if selected, begins, allowing the engine to stabilise before accepting the load.

Load will be automatically transferred from the mains supply to the generator.

 **NOTE: The load transfer signal remains inactive until the Oil Pressure has risen. This prevents excessive wear on the engine.**

In test mode, the set will continue to run *on load* until either:

- The *stop button*  is pressed – The set will immediately stop
- The *auto button*  is pressed. The set will observe all auto mode start requests and stopping timers before beginning the *Auto mode stopping sequence*.

6.6 AUTOMATIC MODE

 **NOTE: If a digital input configured to *panel lock* is active, changing module modes will not be possible. Viewing the instruments and event logs is NOT affected by panel lock.**

Activate auto mode by pressing the  pushbutton. An LED indicator beside the button confirms this action.

Auto mode will allow the generator to operate fully automatically, starting and stopping as required with no user intervention.

6.6.1 WAITING IN AUTO MODE

If a starting request is made, the starting sequence will begin. Starting requests can be from the following sources:

- Mains supply out of limits
- Activation of an auxiliary input that has been configured to *remote start on load* or *remote start off load*.
- Activation of low plant battery charge status (Please see section entitled: *Plant Battery Charging* else where in this manual for more details).
- Activation of the inbuilt exercise scheduler.
- Instruction from external remote telemetry devices using the RS232, RS485 or Ethernet interface

6.6.2 STARTING SEQUENCE

To allow for 'false' start requests such as mains brownouts, the *start delay* timer begins. There are individual start delay timers for each of the different start request types.

Should all start requests be removed during the *start delay* timer, the unit will return to a stand-by state.

If a start request is still present at the end of the *start delay* timer, the fuel relay is energised and the engine will be cranked.

 **NOTE: If the unit has been configured for CAN, compatible ECU's will receive the start command via CAN.**

If the engine fails to fire during this cranking attempt then the starter motor is disengaged for the *crank rest* duration after which the next start attempt begins. Should this sequence continue beyond the set number of attempts, the start sequence will be terminated and the display shows **Fail to Start**.

The starter motor is disengaged when the engine fires. Speed detection is factory configured to be derived from the main alternator output frequency, but can additionally be measured from a Magnetic Pickup mounted on the flywheel (Selected by PC using the configuration software).

Additionally, rising oil pressure can be used to disconnect the starter motor (but cannot detect underspeed or overspeed).

 **NOTE: If the unit has been configured for CAN, speed sensing is via CAN.**

After the starter motor has disengaged, the *Safety On* timer activates, allowing Oil Pressure, High Engine Temperature, Under-speed, Charge Fail and any delayed Auxiliary fault inputs to stabilise without triggering the fault.

6.6.3 ENGINE RUNNING

Once the engine is running, the *Warm Up* timer, if selected, begins, allowing the engine to stabilise before accepting the load. Load will be transferred from the mains supply to the generator

 **NOTE: The load transfer signal remains inactive until the Oil Pressure has risen. This prevents excessive wear on the engine.**

If all start requests are removed, the *stopping sequence* will begin.

6.6.4 STOPPING SEQUENCE

The *return delay* timer operates to ensure that the starting request has been permanently removed and isn't just a short term removal. Should another start request be made during the cooling down period, the set will return on load.

If there are no starting requests at the end of the *return delay* timer, the load is transferred back from the generator to the mains supply and the *cooling* timer is initiated.

The *cooling* timer allows the set to run off load and cool sufficiently before being stopped. This is particularly important where turbo chargers are fitted to the engine.

After the *cooling* timer has expired, the set is stopped.

6.7 PLANT BATTERY CHARGING SCHEME

6.7.1 START REQUEST

Starting requests can be from the following sources:

- The Plant Battery discharges below the level of the Depth of Discharge (DOD) setting

Starting requests are removed when:

- The Plant Battery has been charged to the *Full Charge Level* and has been in the *Floating* charge state for the duration of the configured *Float Charge Timer*.

6.7.2 PLANT BATTERY CHARGE STATE

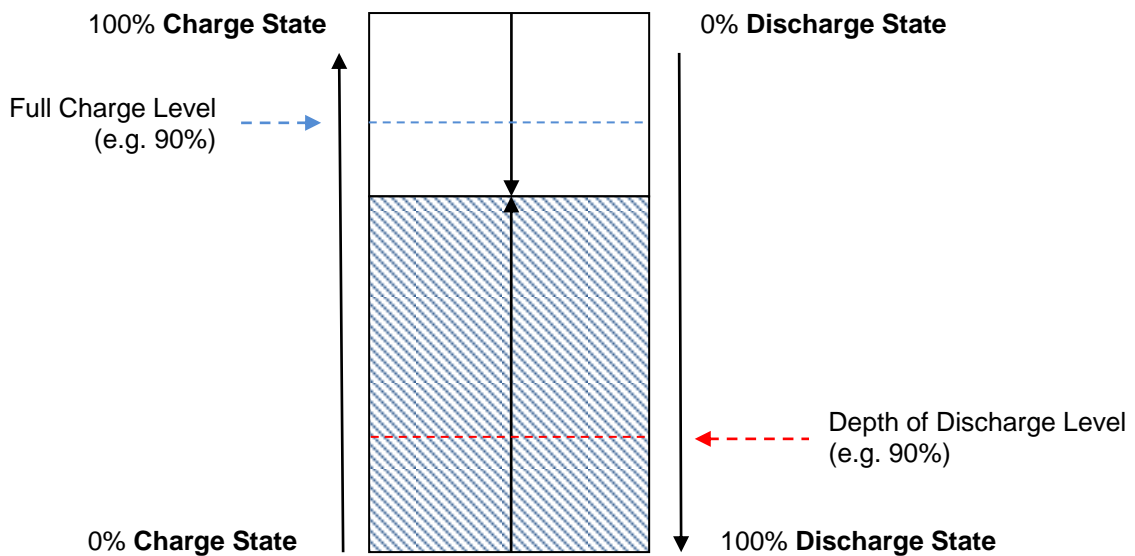

Charge Status	Description			
Discharged	When the Plant Batteries have fallen below the <i>Depth of Discharge Level</i>			
Discharging	When the Plant Batteries' charge current is negative (discharging)			
Charging	When the generator is running and the <i>Charge Current</i> is positive.			
	<table border="1"> <tr> <td>Bulk Stage</td> <td>When the <i>Charge Current</i> is greater than the <i>Battery Charge Rate</i> and when the <i>Battery Voltage</i> is less than the <i>Minimum Float Voltage Level</i></td> </tr> <tr> <td>Absorption Stage</td> <td>When the <i>Plant Battery Voltage</i> is above the <i>Minimum Float Voltage Level</i></td> </tr> </table>	Bulk Stage	When the <i>Charge Current</i> is greater than the <i>Battery Charge Rate</i> and when the <i>Battery Voltage</i> is less than the <i>Minimum Float Voltage Level</i>	Absorption Stage
Bulk Stage	When the <i>Charge Current</i> is greater than the <i>Battery Charge Rate</i> and when the <i>Battery Voltage</i> is less than the <i>Minimum Float Voltage Level</i>			
Absorption Stage	When the <i>Plant Battery Voltage</i> is above the <i>Minimum Float Voltage Level</i>			
Floating	When the Plant Batteries' voltage has fallen below the <i>Minimum Float Charge Voltage</i> and the <i>Charge Current</i> has fallen below the <i>Charge Rate Current</i> .			
Ok	When the Plant Batteries have been charged to the <i>Full Charge Level</i> and has been in the <i>Floating</i> charge state for the duration of the configured <i>Float Charge Timer</i> .			

6.7.3 CALCULATING EFFECTIVE BATTERY CAPACITY

The effective battery capacity is calculated whilst the battery is charging upon a fixed formula:

$$It = C (C / IH)^{K-1}$$

Where: C is the rated capacity (amp hours) of the Plant Batteries combined
IH is the charge rate (amps per hour)
It is the effective battery capacity
K is *Peukert's Constant* (obtained from the battery data sheet or when the battery is calibrated) or by the calculated *Peukert's Constant*

6.7.4 CHARGE CYCLE

A single charge cycle is determined by the following sequence:

1. Plant Batteries fall below *Depth of Discharge (DOD) Level*
2. Plant Batteries are charged to the *Full Charge Level*
3. Plant Batteries start to discharge and reach *Depth of Discharge (DOD) Level*

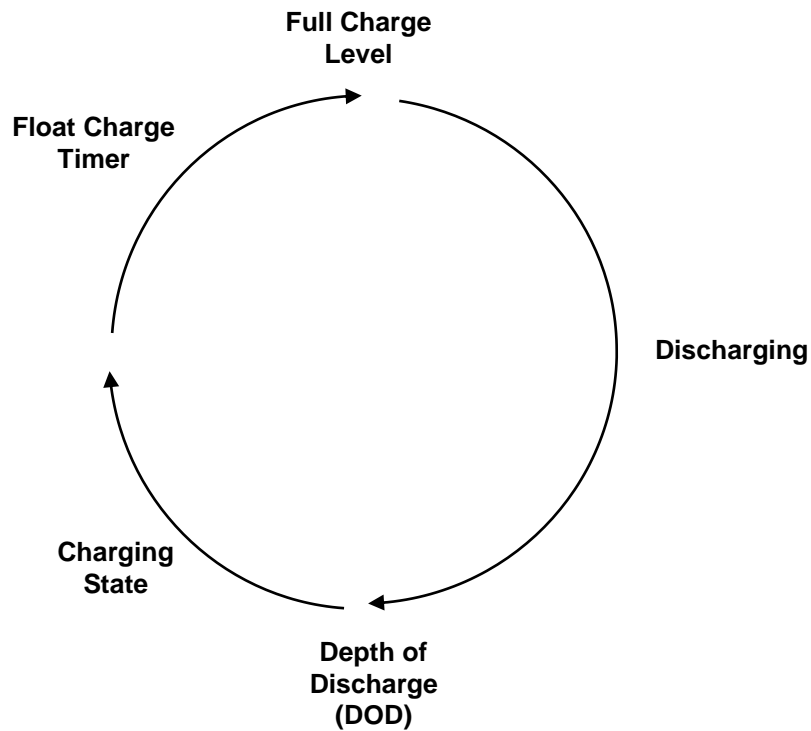

6.7.5 DETERMINING THE CHARGE MODE

6.7.5.1 TWO STAGE CHARGER

NOTE: When using a two stage charger, the Minimum Float Voltage Level must be set higher than the float voltage produced by the charging device as shown below.

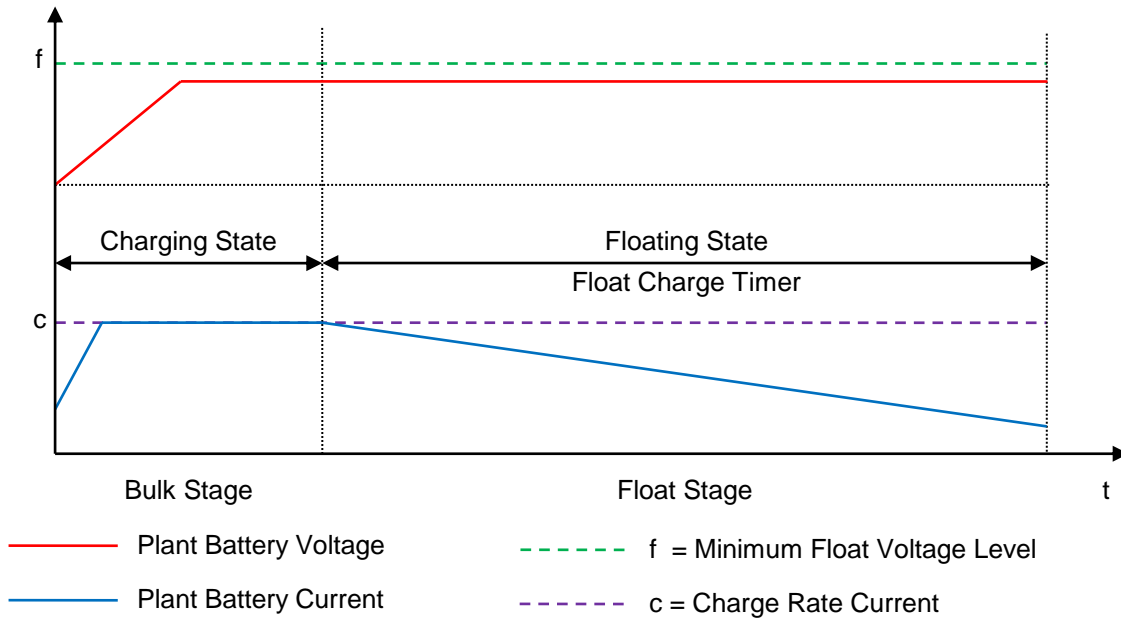

The charge modes for a two stage charger are determined as follows:

Charge Status	Description
Discharged	When the Plant Batteries have fallen below the <i>Depth of Discharge Level</i>
Discharging	When the Plant Batteries' charge current is negative (discharging)
Charging	When the generator is running and the <i>Charge Current</i> is positive.
	Bulk Stage When the <i>Charge Current</i> is greater than the <i>Battery Charge Rate</i> and when the <i>Battery Voltage</i> is less than the <i>Minimum Float Voltage Level</i>
Floating	When the Plant Batteries' voltage has fallen below the <i>Minimum Float Charge Voltage</i> and the <i>Charge Current</i> has fallen below the <i>Charge Rate Current</i> .
Ok	When the Plant Batteries have been charged to the <i>Full Charge Level</i> and has been in the <i>Floating</i> charge state for the duration of the configured <i>Float Charge Timer</i> .

6.7.5.2 THREE STAGE CHARGER

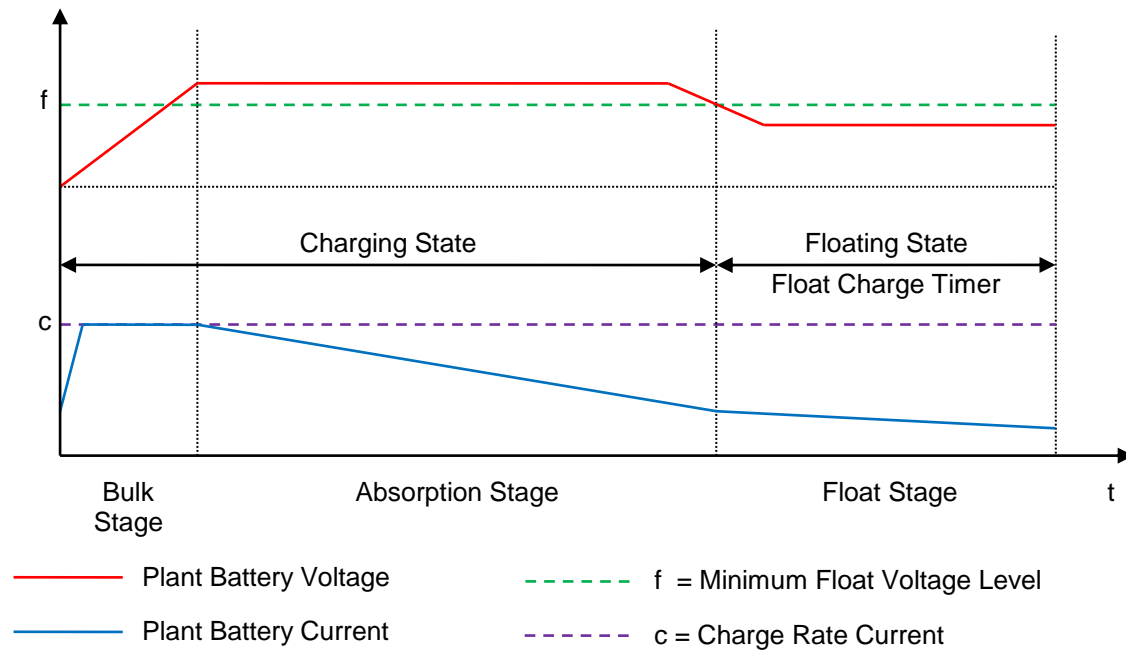

The charge modes for a three stage charger are determined as follows:

Charge Status	Description			
Discharged	When the Plant Batteries have fallen below the <i>Depth of Discharge Level</i>			
Discharging	When the Plant Batteries' charge current is negative (discharging)			
Charging	When the generator is running and the <i>Charge Current</i> is positive.			
	<table border="1" style="width: 100%;"> <tr> <td style="width: 20%;">Bulk Stage</td> <td>When the <i>Charge Current</i> is greater than the <i>Battery Charge Rate</i> and when the <i>Battery Voltage</i> is less than the <i>Minimum Float Voltage Level</i></td> </tr> <tr> <td>Absorption Stage</td> <td>When the <i>Plant Battery Voltage</i> is above the <i>Minimum Float Voltage Level</i></td> </tr> </table>	Bulk Stage	When the <i>Charge Current</i> is greater than the <i>Battery Charge Rate</i> and when the <i>Battery Voltage</i> is less than the <i>Minimum Float Voltage Level</i>	Absorption Stage
Bulk Stage	When the <i>Charge Current</i> is greater than the <i>Battery Charge Rate</i> and when the <i>Battery Voltage</i> is less than the <i>Minimum Float Voltage Level</i>			
Absorption Stage	When the <i>Plant Battery Voltage</i> is above the <i>Minimum Float Voltage Level</i>			
Floating	When the Plant Batteries' voltage has fallen below the <i>Minimum Float Charge Voltage</i> and the <i>Charge Current</i> has fallen below the <i>Charge Rate Current</i> .			
Ok	When the Plant Batteries have been charged to the <i>Full Charge Level</i> and has been in the <i>Floating</i> charge state for the duration of the configured <i>Float Charge Timer</i> .			

6.7.5.3 FOUR STAGE CHARGER

NOTE: When using a four stage charger, the charging device must be permanently powered for the storage charge to occur.

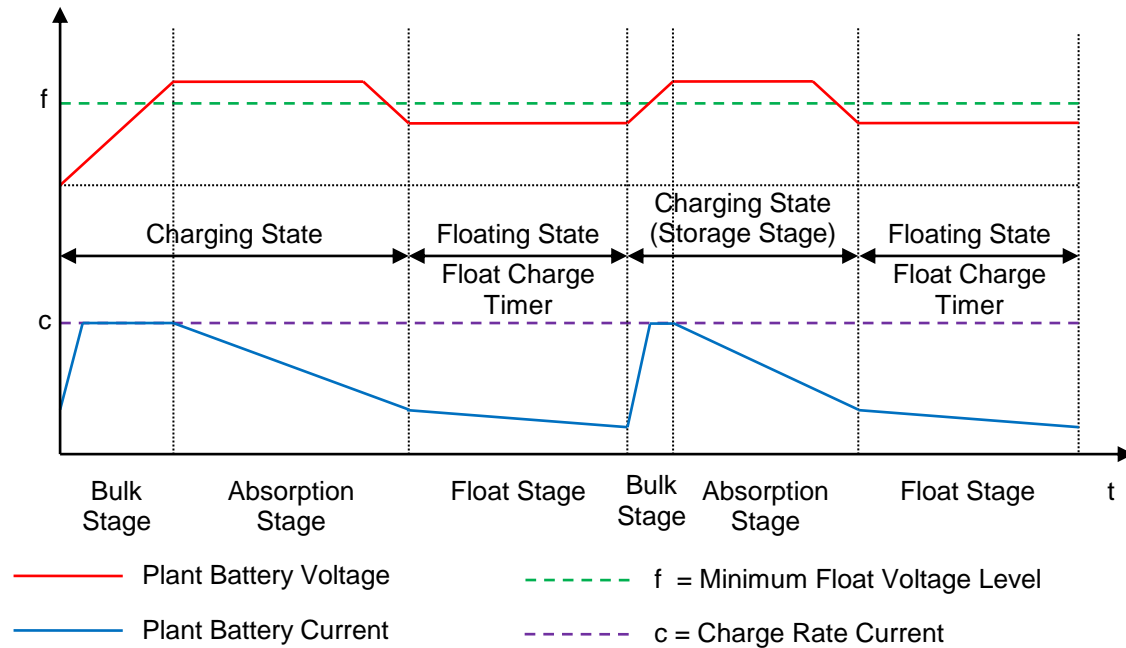

The charge modes for a three stage charger are determined as follows:

Charge Status	Description	
Discharged	When the Plant Batteries have fallen below the <i>Depth of Discharge Level</i>	
Discharging	When the Plant Batteries' charge current is negative (discharging)	
Charging	When the generator is running and the <i>Charge Current</i> is positive.	
	Bulk Stage	When the <i>Charge Current</i> is greater than the <i>Battery Charge Rate</i> and when the <i>Battery Voltage</i> is less than the <i>Minimum Float Voltage Level</i>
	Absorption Stage	When the <i>Plant Battery Voltage</i> is above the <i>Minimum Float Voltage Level</i>
Floating	When the Plant Batteries' voltage has fallen below the <i>Minimum Float Charge Voltage</i> and the <i>Charge Current</i> has fallen below the <i>Charge Rate Current</i> .	
Ok	When the Plant Batteries have been charged to the <i>Full Charge Level</i> and has been in the <i>Floating</i> charge state for the duration of the configured <i>Float Charge Timer</i> .	
Charging (Storage Charge)	When the generator is running and the <i>Charge Current</i> is positive.	
	Bulk Stage	When the <i>Charge Current</i> is greater than the <i>Battery Charge Rate</i> and when the <i>Battery Voltage</i> is less than the <i>Minimum Float Voltage Level</i>
	Absorption Stage	When the <i>Plant Battery Voltage</i> is above the <i>Minimum Float Voltage Level</i>

7 PROTECTIONS

When an alarm is present, the Audible Alarm will sound and the Common alarm LED if configured will illuminate.

The audible alarm can be silenced by pressing the *Mute button* 

The LCD display will jump from the 'Information page' to display the Alarm Page

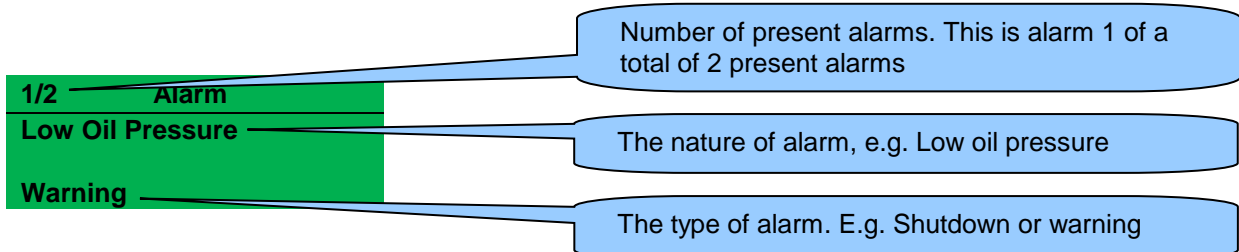

The LCD will display multiple alarms E.g. "High Engine Temperature shutdown", "Emergency Stop" and "Low Coolant Warning". These will automatically scroll in the order that they occurred.

In the event of a warning alarm, the LCD will display the appropriate text. If a shutdown then occurs, the module will again display the appropriate text.

Example:-

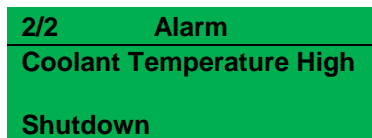
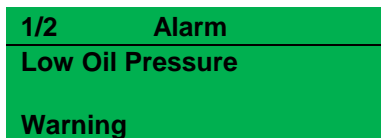

7.1 CAN ERROR MESSAGES

When connected to a suitable CAN engine the controller displays alarm status messages from the ECU.

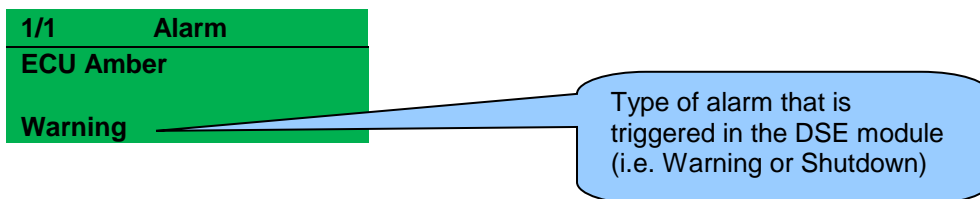

Press  to access the list of current active Engine DTCs (Diagnostic Trouble Codes).

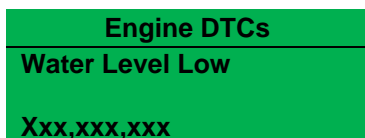

The code interpreted by the module shows on the display as a text message. Additionally, the manufacturer's code is shown.

NOTE: For details on these code meanings, refer to the ECU instructions provided by the engine manufacturer, or contact the engine manufacturer for further assistance.

NOTE: For further details on connection to electronic engines please refer to *Electronic engines and DSE wiring*. Part No. 057-004

7.2 PROTECTIONS DISABLED

User configuration is possible to prevent Shutdown / Electrical Trip alarms from stopping the engine. Under such conditions, *Protections Disabled* will appear on the module display to inform the operator of this status.

This feature is provided to assist the system designer in meeting specifications for “Warning only”, “Protections Disabled”, “Run to Destruction”, “War mode” or other similar wording.

When configuring this feature in the PC software, the system designer chooses to make the feature either permanently active, or only active upon operation of an external switch. The system designer provides this switch (not DSE) so its location will vary depending upon manufacturer, however it normally takes the form of a key operated switch to prevent inadvertent activation. Depending upon configuration, a warning alarm may be generated when the switch is operated.

The feature is configurable in the PC configuration software for the module. Writing a configuration to the controller that has “Protections Disabled” configured, results in a warning message appearing on the PC screen for the user to acknowledge before the controller’s configuration is changed. This prevents inadvertent activation of the feature.

7.2.1 INDICATION / WARNING ALARMS

Under Indication or Warning alarms:

- The module operation is unaffected by the *Protections Disabled* feature. See sections entitled *Indications* and *Warnings* elsewhere in this document.

7.2.2 SHUTDOWN / ELECTRICAL TRIP ALARMS

 **NOTE: The Emergency Stop input and Engine Overspeed Shutdown alarms continue to operate even when *Protections Disabled* has been activated.**

Under Shutdown or Electrical Trip alarm conditions (excluding Emergency Stop and Overspeed):

- The alarm is displayed on the screen as detailed in the section entitled *Shutdown alarms* elsewhere in this document.
- The set continues to run.
- The load switch maintains its current position (it is not opened if already closed)
- **Shutdown Blocked** also appears on the LCD screen to inform the operator that the Protections Disabled feature has blocked the shutdown of the engine under the normally critical fault.
- The ‘shutdown’ alarm is logged by the controllers *Event Log* (if configured to log shutdown alarms) and logs that the Shutdown was prevented.

7.3 INDICATIONS

Indications are non-critical and often status conditions. They do not appear on the LCD of the module as a text message. However, an output or LED indicator can be configured to draw the operator's attention to the event.

Example

- Input configured for indication.
- The LCD text will not appear on the module display but can be added in the configuration to remind the system designer what the input is used for.
- As the input is configured to *Indication* there is no alarm generated.
- LED Indicator to make LED1 illuminate when Digital Input A is active.
- The Insert Card Text allows the system designer to print an insert card detailing the LED function.
- Sample showing operation of the LED.

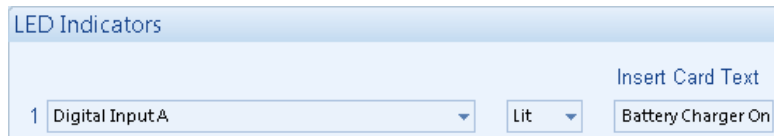
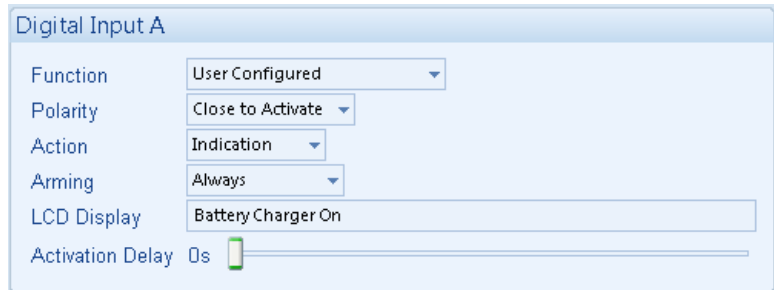

7.4 WARNINGS

Warnings are non-critical alarm conditions and do not affect the operation of the generator system, they serve to draw the operators attention to an undesirable condition.

Example

1/2 Alarm
Low Oil Pressure
Warning

In the event of an alarm the LCD will jump to the alarms page, and scroll through all active warnings and shutdowns.

By default, warning alarms are self-resetting when the fault condition is removed. However enabling 'all warnings are latched' will cause warning alarms to latch until reset manually. This is enabled using the DSE Configuration Suite in conjunction with a compatible PC.

If the module is configured for, **CAN** and receives an "error" message from the engine control unit, 'CAN ECU Amber" is shown on the module's display and a warning alarm is generated.

Display	Reason
Charge Air Temperature	The module detects that the engine ECU has detected the Charge Air Temperature has exceed the pre-alarm trip level.
Charge Alternator Failure	The module detects the auxiliary charge alternator voltage from the W/L terminal has fallen below the pre-alarm level.
Charge Over Current	The module detects that the charge current circuit has exceeded the trip level.
DC High Voltage	The DC supply has risen above the high volts setting level for the duration of the high plant battery volts timer
DC Low Voltage	The DC supply has fallen below the low volts setting level for the duration of the low plant battery volts timer
DC kW Overload	The module detects that the DC kW level has exceeded the pre-alarm trip setting.
Digital Input A to J	If a digital input has been configured as a warning the appropriate LCD message will be displayed.
ECU After Treatment	The module detects that the engine ECU has detected that the after treatment is currently in progress.
ECU Amber	The module detects that the engine ECU has detected a fault causing an Amber alarm.
ECU Protect	The module detects that the engine ECU has detected a fault causing a Protect alarm.
ECU Malfunction	The module detects that the engine ECU has detected a fault causing a Malfunction alarm.
ECU Red	The module detects that the engine ECU has detected a fault causing a Red alarm.
ECU Water In Fuel	The module detects that the engine ECU has detected that there is water in the fuel.
Engine Battery High Voltage	The Engine DC supply has risen above the high volts setting level for the duration of the high battery volts timer
Engine Battery Low Voltage	The Engine DC supply has fallen below the low volts setting level for the duration of the low battery volts timer
Engine Maintenance Alarm 1, 2 & 3	Indicates that the engine maintenance alarm has triggered. A visit is required by the Generator service company.

Protections

Display	Reason
Flexible Sender 1,2 & 3 Digital Input	If a flexible sensor has been configured to a digital input and has been configured as a warning the appropriate LCD message will be displayed.
Flexible Sender 1,2 & 3 High	The module detects that the value of the sensor has increased pre-alarm setting.
Flexible Sender 1,2 & 3 Low	The module detects that the value of the sensor has fallen below pre-alarm setting.
Fuel Usage	Indicates the amount of fuel measured by the fuel level sensor is in excess of the <i>Fuel Usage</i> alarm settings. This often indicates a fuel leak or potential fuel theft.
Generator Breaker Failed To Open	If the generator breaker fails to open, a warning is initiated. The LCD will indicate ' Generator Failed To Open '.
Generator Over Frequency	The generator output AC frequency has risen above the pre-alarm setting.
Generator Over Voltage	The generator output AC voltage has risen above the pre-alarm setting.
Generator Under Frequency	The generator output AC frequency has fallen below the pre-alarm setting after the <i>Safety On</i> timer has expired.
Generator Under Voltage	The generator output AC voltage has fallen below the pre-alarm setting after the <i>Safety On</i> timer has expired.
High Current	A High Current condition occurred. For further details of the high current alarm, please see High Current Shutdown / Electrical Trip Alarm.
High Current IDMT	A High DC Current condition has continued for an excess period. For further details of the high current alarm, please see High Current Shutdown / Electrical Trip Alarm.
High Coolant Temperature	The module detects that the engine coolant temperature has exceeded the high engine temperature pre-alarm setting level after the <i>Safety On</i> timer has expired.
Load Over Current	The module detects that the Load Current has exceeded the trip level.
Low Coolant Temperature	The module detects that the engine coolant temperature has fallen below the high engine temperature pre-alarm setting level.
Low Fuel Level	The level detected by the fuel level sensor is below the low fuel level setting.
Low Oil Pressure	The module detects that the engine oil pressure has fallen below the low oil pressure pre-alarm setting level after the <i>Safety On</i> timer has expired.
Loss Of Speed Sensing	The speed signal from the magnetic pickup is not being received by the DSE controller.
Magnetic Pickup Open Circuit	The module detects that the circuit to the MPU has been broken.
Mains Breaker Failed To Close	If the mains breaker fails to close, a warning is initiated. The LCD will indicate ' Mains Failed To Close '.
Mains Breaker Failed To Open	If the mains breaker fails to open, a warning is initiated. The LCD will indicate ' Mains Failed To Open '.
Overspeed	The module detects that the engine speed has risen above the overspeed pre alarm setting.

Protections

Display	Reason
Plant Battery High Temperature	The module detects that the plant battery temperature has exceeded the high plant battery temperature pre-alarm setting.
Plant Battery Low Temperature	The module detects that the plant battery temperature has fallen below the high plant battery temperature pre-alarm setting.
Plant Battery Maintenance Alarm 1,2 & 3	Indicates that the Plant Battery maintenance alarm has triggered. A visit is required by the Generator service company.
Plant Battery Over Depth of Discharge	The module detects that the plant battery has fallen below the Depth of Discharge pre-alarm setting
Protection Disabled	Shutdown and electrical trip alarms can be disabled by user configuration. In this case, Protections Disabled will appear on the module display; The alarm text is displayed but the engine will continue to run. This is 'logged' by the module to allow DSE Technical Staff to check if the protections have been disabled on the module at any time.
Short Circuit Current	The module detects that the short circuit has exceeded the trip level.
Shutdown Blocked	The module detects that a shutdown or electrical trip has been blocked due to the module's protection being disabled.
Underspeed	The engine speed has fallen below the underspeed pre alarm setting

7.5 ELECTRICAL TRIPS

NOTE: Shutdown and Electrical Trip alarms can be disabled by user configuration. See the section entitled *Protections Disabled* elsewhere in this document.

Electrical trips are latching and stop the Generator but in a controlled manner. On initiation of the electrical trip condition the module will de-energise the '**Close Generator**' Output to remove the load from the generator. Once this has occurred the module will start the Cooling timer and allow the engine to cool off-load before shutting down the engine. The alarm must be accepted and cleared, and the fault removed to reset the module.

Example

1/2 Alarm
High Coolant Temperature
Electrical Trip

Electrical trips are latching alarms and stop the Generator. Remove the fault then press Stop/Reset



to reset the module.

NOTE: The alarm condition must be rectified before a reset will take place. If the alarm condition remains, it will not be possible to reset the unit (The exception to this is the Low Oil Pressure alarm and similar 'active from safety on' alarms, as the oil pressure will be low with the engine at rest).

Display	Reason
Charge Air Temperature	The module detects that the engine ECU has detected the Charge Air Temperature has exceed the trip level.
Charge Over Current	The module detects that the charge current circuit has exceeded the trip level.
DC High Voltage	The DC supply has risen above the high volts setting level for the duration of the high plant battery volts timer
DC Low Voltage	The DC supply has fallen below the low volts setting level for the duration of the low plant battery volts timer
DC kW Overload	The module detects that the DC kW level has exceeded the alarm trip setting.
Digital Input A to J	If a digital input has been configured as an electrical trip, the appropriate LCD message will be displayed.
ECU After Treatment	The module detects that the engine ECU has detected that the after treatment is currently in progress.
ECU Amber	The module detects that the engine ECU has detected a fault causing an Amber alarm.
ECU Protect	The module detects that the engine ECU has detected a fault causing a Protect alarm.
ECU Malfunction	The module detects that the engine ECU has detected a fault causing a Malfunction alarm.
ECU Red	The module detects that the engine ECU has detected a fault causing a Red alarm.
ECU Water In Fuel	The module detects that the engine ECU has detected that there is water in the fuel.

Protections

Display	Reason
Flexible Sender 1,2 & 3 Digital Input	If a flexible sensor has been configured to a digital input and has been configured as an electrical trip, the appropriate LCD message will be displayed.
Flexible Sender 1,2 & 3 High	The module detects that the value of the sensor has increased alarm setting.
Flexible Sender 1,2 & 3 Low	The module detects that the value of the sensor has fallen below alarm setting.
Fuel Usage	Indicates the amount of fuel measured by the fuel level sensor is in excess of the <i>Fuel Usage</i> alarm settings. This often indicates a fuel leak or potential fuel theft.
Generator Failed To Close	If the generator breaker fails to close, an electrical trip alarm is initiated. The LCD will indicate ' Generator Failed To Close '.
High Current	A High Current condition occurred. For further details of the high current alarm, please see High Current Shutdown / Electrical Trip Alarm.
High Current IDMT	A High DC Current condition has continued for an excess period. For further details of the high current alarm, please see High Current Shutdown / Electrical Trip Alarm.
High Coolant Temperature	The module detects that the engine coolant temperature has exceeded the high engine temperature trip alarm setting level after the <i>Safety On</i> timer has expired.
Load Over Current	The module detects that the Load Current has exceeded the trip level.
Low Fuel Level	The level detected by the fuel level sensor is below the low fuel level trip setting.
Plant Battery Maintenance Alarm 1,2 & 3	Indicates that the plant battery maintenance alarm has triggered. A visit is required by the Generator service company.
Plant Battery Over Depth of Discharge	The module detects that the plant battery has fallen below the Depth of Discharge trip alarm setting
Short Circuit Current	The module detects that the short circuit has exceeded the trip level.

7.6 SHUTDOWNS

▲NOTE: Shutdown and Electrical Trip alarms can be disabled by user configuration. See the section entitled *Protections Disabled* elsewhere in this document.

Shutdowns are latching alarms and stop the Generator. Clear the alarm and remove the fault then press Stop/Reset  to reset the module.

Example

1/2	Alarm
Low Oil Pressure	
Shutdown	

▲NOTE: The alarm condition must be rectified before a reset will take place. If the alarm condition remains, it will not be possible to reset the unit (The exception to this is the Low Oil Pressure alarm and similar 'active from safety on' alarms, as the oil pressure will be low with the engine at rest).

Display	Reason
Air Flap Closed Alarm	The module detects the air flap has closed.
Calibration Lost	The module detects it has lost its calibration and should be sent back to DSE for repair.
Charge Alternator Failure	The module detects the auxiliary charge alternator voltage from the W/L terminal has fallen below the trip level.
Charge Air Temperature	The module detects that the engine ECU has detected the Charge Air Temperature has exceed the trip level.
Charge Over Current	The module detects that the charge current circuit has exceeded the trip level.
Coolant Temperature Sender Open Circuit	The module detects that the circuit to the coolant temperature sensor has been broken.
Emergency Stop	The module detects that the emergency stop has been pressed from the emergency stop terminal
DC High Voltage	The DC supply has risen above the high volts setting level for the duration of the high plant battery volts timer
DC Low Voltage	The DC supply has fallen below the low volts setting level for the duration of the low plant battery volts timer
DC kW Overload	The module detects that the DC kW level has exceeded the alarm trip setting.
Digital Input A to J	If a digital input has been configured as an electrical trip, the appropriate LCD message will be displayed.

Protections

Display	Reason
ECU After Treatment	The module detects that the engine ECU has detected that the after treatment is currently in progress.
ECU Amber	The module detects that the engine ECU has detected a fault causing an Amber alarm.
ECU Protect	The module detects that the engine ECU has detected a fault causing a Protect alarm.
ECU Malfunction	The module detects that the engine ECU has detected a fault causing a Malfunction alarm.
ECU Red	The module detects that the engine ECU has detected a fault causing a Red alarm.
ECU Water In Fuel	The module detects that the engine ECU has detected that there is water in the fuel.
Engine Maintenance Alarm 1, 2 & 3	Indicates that the engine maintenance alarm has triggered. A visit is required by the Generator service company.
Fail to Start	The module has detected that the engine has failed to start after the configured number of start attempts.
Flexible Sender 1,2 & 3 Digital Input	If a flexible sensor has been configured to a digital input and has been configured as an electrical trip, the appropriate LCD message will be displayed.
Flexible Sender 1,2 & 3 High	The module detects that the value of the sensor has increased alarm setting.
Flexible Sender 1,2 & 3 Low	The module detects that the value of the sensor has fallen below alarm setting.
Fuel Usage	Indicates the amount of fuel measured by the fuel level sensor is in excess of the <i>Fuel Usage</i> alarm settings. This often indicates a fuel leak or potential fuel theft.
Generator Over Frequency	The generator output AC frequency has risen above the alarm trip setting.
Generator Over Voltage	The generator output AC voltage has risen above the alarm trip setting.
Generator Under Frequency	The generator output AC frequency has fallen below the alarm trip setting after the <i>Safety On</i> timer has expired.
Generator Under Voltage	The generator output AC voltage has fallen below the alarm trip setting after the <i>Safety On</i> timer has expired.
Generator Phase Rotation	The module detects that the phase rotation of the generator does not match the configured setting.
High Current	A High Current condition occurred. For further details of the high current alarm, please see High Current Shutdown / Electrical Trip Alarm.
High Current IDMT	A High DC Current condition has continued for an excess period. For further details of the high current alarm, please see High Current Shutdown / Electrical Trip Alarm.

Protections

Display	Reason
Load Over Current	The module detects that the Load Current has exceeded the trip level.
Low Fuel Level	The level detected by the fuel level sensor is below the low fuel level setting.
Low Oil Pressure	The module detects that the engine oil pressure has fallen below the low oil pressure alarm trip setting level after the <i>Safety On</i> timer has expired.
Oil Pressure Sender Open Circuit	The module detects that the circuit to the oil pressure sensor has been broken.
Loss Of Speed Sensing	The speed signal from the magnetic pickup is not being received by the DSE controller.
Magnetic Pickup Open Circuit	The module detects that the circuit to the MPU has been broken.
Overspeed	The engine speed has risen above the overspeed alarm trip setting
Plant Battery High Temperature	The module detects that the plant battery temperature has exceeded the high plant battery temperature pre-alarm setting.
Plant Battery Low Temperature	The module detects that the plant battery temperature has fallen below the high plant battery temperature pre-alarm setting.
Plant Battery Maintenance Alarm 1,2 & 3	Indicates that the Plant Battery maintenance alarm has triggered. A visit is required by the Generator service company.
Plant Battery Over Depth of Discharge	The module detects that the plant battery has fallen below the Depth of Discharge alarm trip setting
Short Circuit Current	The module detects that the short circuit has exceeded the trip level.
Underspeed	The engine speed has fallen below the underspeed alarm trip setting

7.7 DC OVERCURRENT WARNING/ ELECTRICAL TRIP/SHUTDOWN ALARM

The overcurrent alarm combines a simple warning trip level with a fully functioning IDMT curve for thermal protection.

7.7.1 IMMEDIATE WARNING

If the *Immediate Warning* is enabled, the controller generates a *warning alarm* as soon as the *Trip* level is reached. The alarm automatically resets once the generator loading current falls below the *Trip* level (unless *All Warnings are latched* is enabled). For further advice, consult your generator supplier.

7.7.2 IDMT ALARM

If the *IDMT Alarm* is enabled, the controller begins following the IDMT 'curve' when the *trip* level is passed.

If the *Trip* is surpassed for an excess amount of time the *IDMT Alarm* triggers (*Shutdown* or *Electric trip* as selected in *Action*).

High Current Shutdown is a latching alarm and stops the Generator.

Remove the fault then press Stop/Reset  to reset the module.

High Current Electrical Trip is a latching alarm and removes the generator from the load, before stopping the Generator after the off load *cooling* timer.

Remove the fault then press Stop/Reset  to reset the module.

The higher the overload, the faster the trip. The speed of the trip is dependent upon the fixed formula:

$$T = t / ((I_A / I_T) - 1)^2$$

Where: T is the tripping time in seconds

I_A is the actual current

I_T is the delayed over-current trip point

t is the time multiplier setting and also represents the tripping time in seconds at twice full load (when $I_A / I_T = 2$).

Protections

Factory settings for the *IDMT Alarm* are as follows (screen capture from the DSE Configuration Suite PC software):

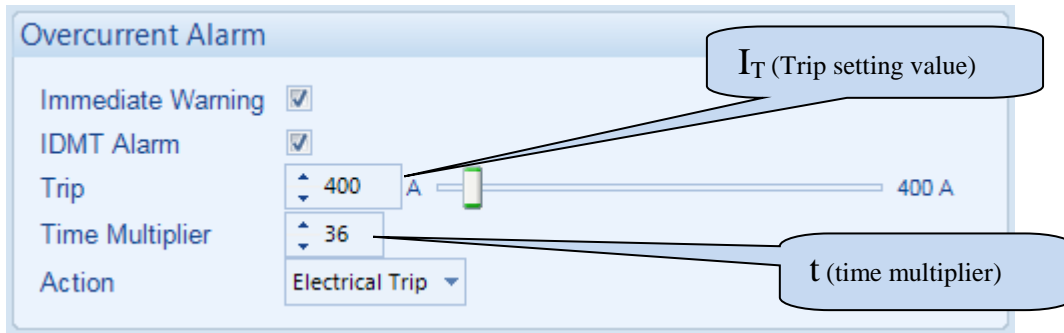

These settings provide for normal running of the generator up to full load. If full load is surpassed, the *Immediate Warning* alarm is triggered, the set continues to run.

The effect of an overload on the DC wiring is that it begin to overheat; the aim of the *IDMT alarm* is to prevent the wiring being overload (heated) too much. The amount of time that the set can be safely overloaded is governed by how high the overload condition is.

With typical settings as above, the tripping curve is followed as shown below.

This allows for overload of the wiring whereby 110% overload is permitted for 1 hour.

If the load reduces, the controller then *follows* a cooling curve. This means that a second overload condition may trip much sooner than the first as the controller *knows* if the wiring has not cooled sufficiently.

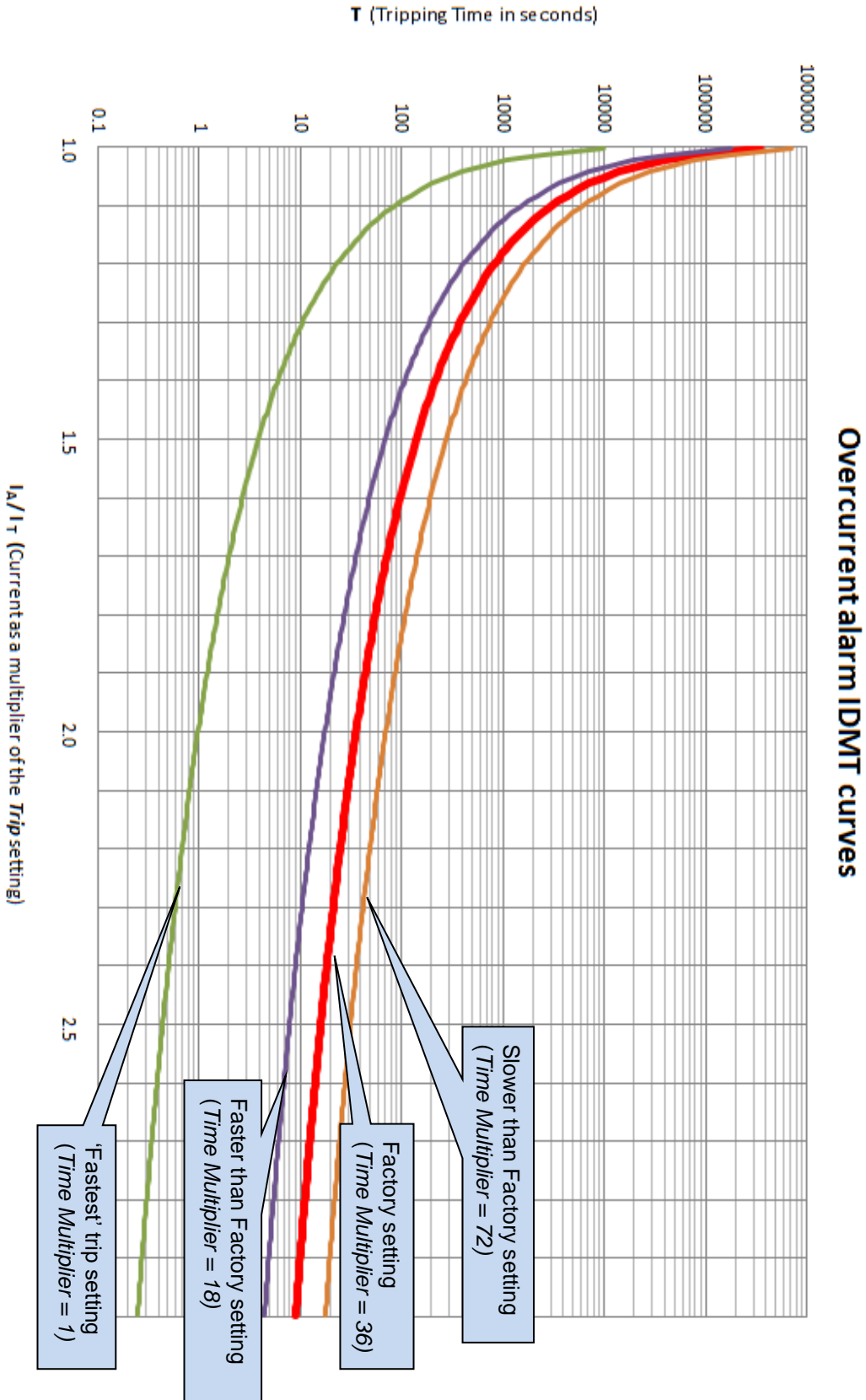

7.8 DC SHORT CIRCUIT ALARM

If the *Short Circuit alarm* is enabled, the controller begins following the IDMT 'curve'. If the *Trip* is surpassed for an excess amount of time the Alarm triggers (*Shutdown* or *Electrical trip* as selected in *Action*).

The higher the Short Circuit, the faster the trip. The speed of the trip is dependent upon the fixed formula :

$$T = K \times 0.14 / ((I / I_s)^{0.02} - 1)$$

Where: T is the tripping time in seconds (accurate to +/- 5% or +/- 50ms (whichever is the greater)
 K is the time multiplier setting
 I is the actual current measured
 Is is the trip setting value

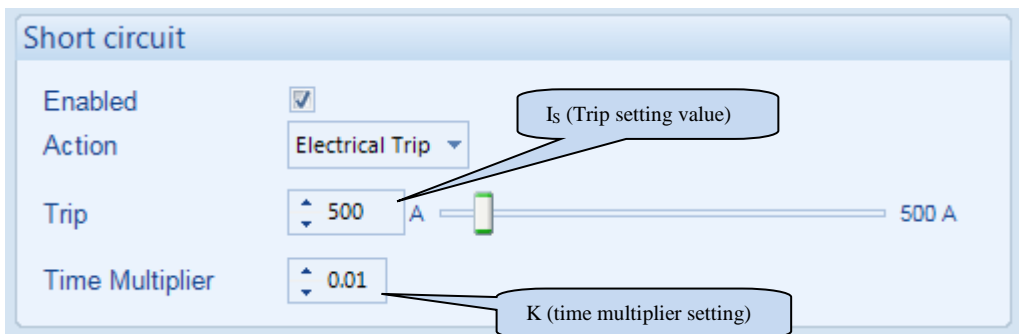

The settings shown in the example above are a screen capture of the DSE factory settings, taken from the DSE Configuration Suite software.

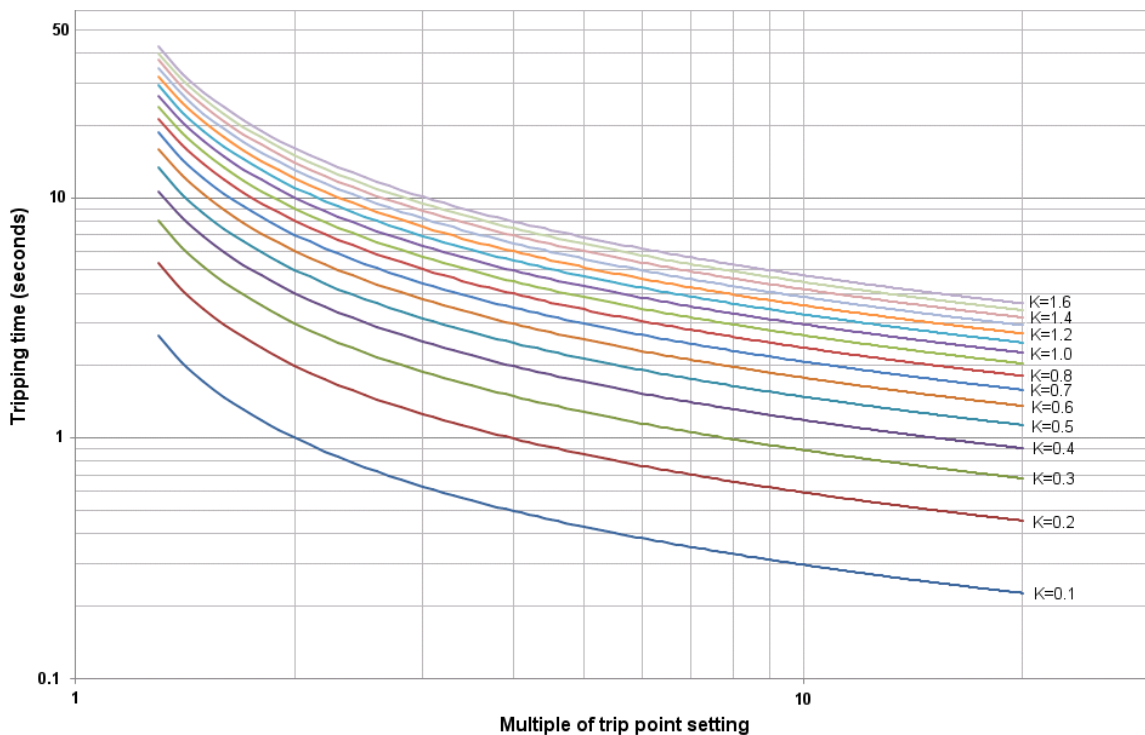

7.9 MAINTENANCE ALARM

Depending upon module configuration one or more levels of engine or plant battery maintenance alarm may occur based upon a configurable schedule.

Example 1

Screen capture from DSE Configuration Suite Software showing the configuration of Plant Battery Maintenance Alarm 1 and Maintenance Alarm 2.

When activated, the maintenance alarm can be either a **warning** (set continues to run) or **shutdown** (running the set is not possible). Resetting the maintenance alarm is normally actioned by the site service engineer after performing the required maintenance. The method of reset is either by:

- Activating a input that has been configured to maintenance x reset, where x is the number of the maintenance alarm (1 to 3).
- Pressing the maintenance reset button in the DSE Configuration Suite, Maintenance section.

The image shows two screenshots of the DSE Configuration Suite software. The top screenshot is for 'Plant Battery Maintenance Alarm 1'. It has an 'Enable' checkbox checked, a 'Description' field containing 'Battery Maintenance Alarm 1', and an 'Action' dropdown set to 'Warning'. Below are three rows for 'Run Time', 'Maintenance Interval', and 'Cycles', each with a checked checkbox, a numeric input field set to '10', and a unit dropdown (hrs, months, Cycles) with a corresponding slider control. The bottom screenshot is for 'Plant Battery Maintenance Alarm 2', which has identical configuration options.

Example 2

Screen capture from DSE Configuration Suite Software showing the configuration of a digital input for Reset DC Battery Maintenance Alarm 1.

The image shows a screenshot of the 'Digital Input A' configuration screen. The 'Function' dropdown is set to 'Reset DC Battery Maintenance Alarm 1'. The 'Polarity' dropdown is set to 'Close to Activate'. There are also dropdowns for 'Action' and 'Arming'. The 'LCD Display' field is empty. The 'Activation Delay' is set to '0s' with a slider control.

Example 3

Screen capture from DSE Configuration Suite Software showing the Maintenance Alarm Reset 'button' in the DSE Configuration Suite SCADA | MAINTENANCE section.

The image shows a screenshot of the 'Battery Maintenance Alarm 1' interface. It displays the following information: 'Running Time Until Next Maintenance' (10:00), 'Date Of Next Maintenance' (17/10/2013 12:06:27), and 'Battery Cycles to Next Maintenance' (10). At the bottom, there is a blue 'Reset' button and a message: 'Press reset to schedule next maintenance, based upon module's maintenance configuration.'

8 SCHEDULER

The controller contains an inbuilt exercise run scheduler, capable of automatically starting and stopping the set. Up to 16 scheduled start/stop sequences can be configured to repeat on a 7-day or 28-day cycle.

Scheduled runs may be on load or off load depending upon module configuration.

Example

Screen capture from DSE Configuration Suite Software showing the configuration of the Exercise Scheduler.

In this example the set will start at 09:00 on Monday and run for 5 hours, then start at 13:30 on Tuesday and run for 30 minutes.

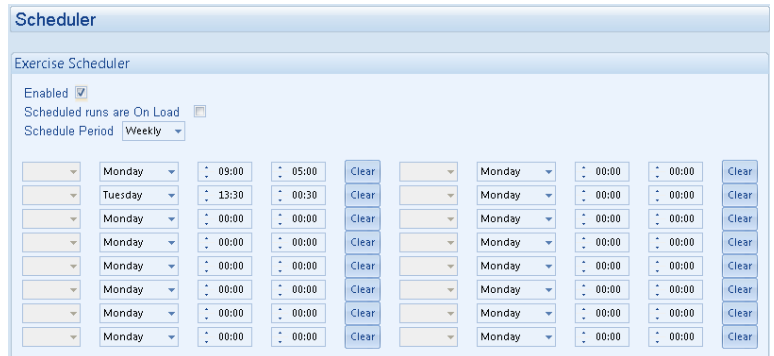





8.1.1 STOP MODE

- Scheduled runs will not occur when the module is in STOP/RESET  mode.

8.1.2 MANUAL MODE

- Scheduled runs will not occur when the module is in MANUAL  mode.
- Activation of a Scheduled Run 'On Load' when the module is operating OFF LOAD in Manual mode will force the set to run ON LOAD

8.1.3 AUTO MODE

- Scheduled runs will operate ONLY if the module is in AUTO  mode with no Shutdown or Electrical Trip alarm present.
- If the module is in STOP  or MANUAL  mode when a scheduled run begins, the engine will not be started. However, if the module is moved into AUTO  mode during a scheduled run, the engine will be called to start.
- Depending upon configuration by the system designer, an external input can be used to inhibit a scheduled run.
- If the engine is running OFF LOAD in AUTO  mode and a scheduled run configured to 'On Load' begins, the set is placed ON LOAD for the duration of the Schedule.

8.1.4 TEST MODE

- Scheduled runs will not occur when the module is in TEST  mode.
- Activation of a Scheduled Run 'On Load' when the module is operating OFF LOAD in Test mode will force the set to run ON LOAD

9 FRONT PANEL CONFIGURATION

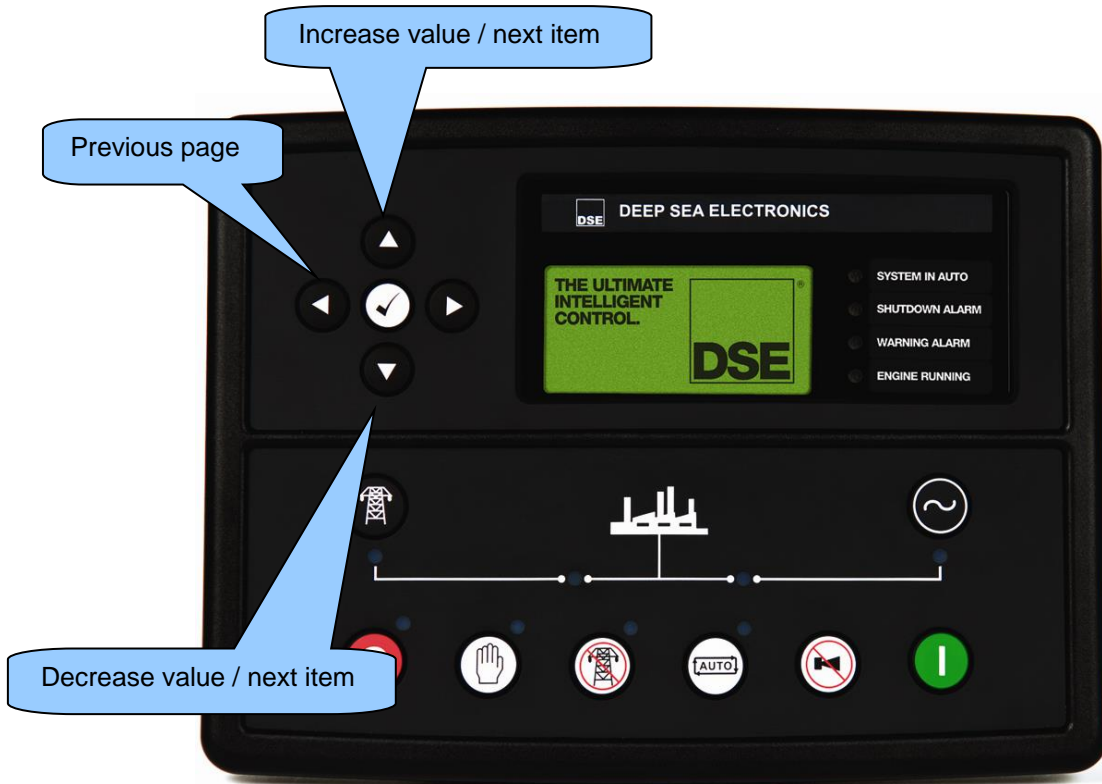

This configuration mode allows the operator limited customising of the way the module operates.

Use the module's navigation buttons to traverse the menu and make value changes to the parameters:



9.1 ACCESSING THE MAIN FRONT PANEL CONFIGURATION EDITOR

Ensure the engine is at rest and the module is in STOP mode by pressing the Stop/Reset  button.

Press the Stop/Reset  and Info  buttons simultaneously.

If a module security PIN has been set, the PIN number request is then shown :

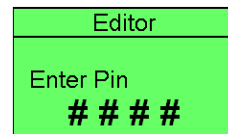

Press , the first '#' changes to '0'. Press  (up or down) to adjust it to the correct value.

Press  (right) when the first digit is correctly entered. The digit you have just entered will now show '#' for security.

Repeat this process for the other digits of the PIN number. You can press  (left) if you need to move back to adjust one of the previous digits.

When  is pressed after editing the final PIN digit, the PIN is checked for validity. If the number is not correct, you must re-enter the PIN.

If the PIN has been successfully entered (or the module PIN has not been enabled), the editor is displayed :

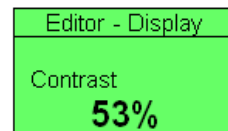



 **NOTE: The PIN number is not set by DSE when the module leaves the factory. If the module has a PIN code set, this has been affected by your generator supplier who should be contacted if you require the code. If the code has been 'lost' or 'forgotten', the module must be returned to the DSE factory to have the module's code removed. A charge will be made for this procedure.**

NB - This procedure cannot be performed away from the DSE factory.

9.1.1 EDITING A PARAMETER

Enter the editor as described above.

Press the  (left) or  (right) buttons to cycle to the section you wish to view/change.

Press the  (up or down) buttons to select the parameter you wish to view/change within the currently selected section.

To edit the parameter, press  to enter edit mode. The parameter begins to flash to indicate that you are editing the value.

Press the  (up or down) buttons to change the parameter to the required value.

Press  to save the value. The parameter ceases flashing to indicate that it has been saved.

To exit the editor at any time, press and hold the  or  button.

 **NOTE: The editor automatically exits after 5 minutes of inactivity to ensure security.**

 **NOTE: The PIN number is automatically reset when the editor is exited (manually or automatically) to ensure security.**

 **NOTE: More comprehensive module configuration is possible via PC configuration software. Refer to DSE7450 PC Configuration Suite Manual (DSE part 057-169) for further details on configuring, monitoring and control.**

9.2 ADJUSTABLE PARAMETERS

Front Panel Configuration Editor. For descriptions of the parameters, you are referred to The DSE series Configuration Suite Manual, DSE Part 057-160.

Section	Parameter As Shown On Display	Values
Display	Contrast	0%
	Language	English
	Current Date and Time	hh:mm
Engine	Oil Pressure Low shutdown	0.00 bar 0 psi 0 kPa
	Oil Pressure Low Pre-Alarm	0.00 bar 0 psi 0 kPa
	Coolant Temp High Pre-Alarm	0°C 0°F
	Coolant Temp High Electrical Trip	0°C 0°F (When Enabled)
	Coolant Temp High Shutdown	0°C 0°F
	Start Delay Off load	0h 0m 0s
	Start Delay On load	0h 0m 0s
	Start Delay Mains Fail	0h 0m 0s
	Start Delay Telemetry	0h 0m 0s
	Pre Heat Timer	0m 0s
	Crank Duration	0s
	Crank rest Time	0m 0s
	Safety On Delay	0m 0s
	Smoke Limiting	0m 0s
	Smoke limiting off	0m 0s
	Warm Up Time	0h 0m 0s
	Cool Down Time	0h 0m 0s
	Underspeed Shutdown	Inactive/Active
	Underspeed Shutdown (If Active)	0 rpm
	Underspeed Warning	Inactive/Active
	Underspeed Warning (If Active)	0 rpm
	Overspeed Warning	Inactive/Active
	Overspeed Warning (If Active)	0 rpm
	Overspeed Shutdown	0 rpm
	Speed Overshoot Delay	0s
	Speed Overshoot	0%
	Fail To Stop Delay	0m 0s
	Battery Under Volts Warning	Active/Inactive
	Battery Under Volts Warning Delay (If Active)	0h 0m 0s
	Battery Under Volts Warning (If Active)	0V
	Battery Over Volts Warning	Active/Inactive
	Battery Over Volts Warning Delay (If Active)	0h 0m 0s
	Battery Over Volts Warning (If Active)	0V
Charge Alternator Failure Warning	Active/Inactive	
Charge Alternator Failure Warning (If Active)	0V	
Charge Alternator Warning Delay (If Active)	0h 0m 0s	
Charge Alternator Failure Shutdown	Inactive/Active	
Charge Alternator Failure Shutdown (If Active)	0V	
Charge Alternator Shutdown Delay (If Active)	0s	

More parameters overleaf...

Front Panel Configuration

Section	Parameter As Shown On Display	Values
Generator	AVR Tgt	0.00V
	Under Voltage Shutdown	0V
	Under Voltage Pre-Alarm	0V
	Nominal Voltage	0V
	Over Voltage Pre-Alarm	0V
	Over Voltage Shutdown	0V
	Under Frequency Shutdown	0Hz
	Under Frequency Pre-Alarm	0Hz
	Nominal Frequency	0Hz
	Over Frequency Pre-Alarm	0Hz
	Over Frequency Shutdown	0Hz
	AC System	3 Phase 4 Wire
	Transient Delay	0s
Mains	Under Voltage Trip	0V
	Over Voltage Trip	0V
	Under Frequency Trip	0Hz
	Over Frequency Trip	0Hz
	Transient Delay	0s
Timers	LCD Page Timer	0h 0m 0s
	Scroll Delay	0h 0m 0s
	Engine Pre Heat Timer	0m 0s
	Engine Crank Duration	0s
	Engine Crank Rest Time	0s
	Engine Safety On Delay	0s
	Engine Smoke Limiting	0s
	Engine Smoke Limiting Off	0s
	Engine Warm Up Time	0s
	Engine Cool Down Time	0m
	Engine Speed Overshoot Delay	0s
	Engine Failed To Stop Delay	0s
	Battery Under Voltage Warning Delay	0m
	Battery Over Voltage Warning Delay	0m
	Return Delay	0s
	Generator Transient Delay	0s
	Mains Transient Delay	0s
Scheduler	Schedule	Active/Inactive
	Schedule On Load	Active/Inactive (Only Available When Scheduler Is Active)
	Schedule Period Weekly	Weekly, Monthly (Only Available When Scheduler Is Active)
	On Load (Weekly selected) (1-16 Schedule Events available)	Start Time 00h:00m Run Time 00h:00m M T W T F S S
	On Load (Monthly selected) (1-16 Schedule Events available)	Week 1,2,3,4 Start Time 00h:00m Run Time 00h:00m M T W T F S S

More parameters overleaf...

Front Panel Configuration

Section	Parameter As Shown On Display	Values
Battery Spec	Battery Capacity	0Ah
	Battery Charge Rate	0h
	Depth of Discharge	0%
	Full Charge Level	0%
	Floating Min Voltage	0.0V
	Peukert's Constant	1.00
	Plant Battery Low Temperature Shutdown	Inactive/Active
	Plant Battery Low Temperature Shutdown	0°C 0°F
	Plant Battery Low Temperature Warning	Inactive/Active
	Plant Battery Low Temperature Warning (If Active)	0°C 0°F
	Plant Battery Low Temperature Warning Return (If Active)	0°C 0°F
	Plant Battery High Temperature Warning	Inactive/Active
	Plant Battery High Temperature Warning Return (If Active)	0°C 0°F
	Plant Battery High Temperature Warning (If Active)	0°C 0°F
	Plant Battery High Temperature Shutdown (If Active)	0°C 0°F
	Depth of Discharge Warning	Inactive/Active
	Depth of Discharge Warning	0%
	Depth of Discharge Warning Return	0%
	Depth of Discharge Warning Delay	0h 0m 0s
	Depth of Discharge Shutdown	Inactive/Active
Depth of Discharge Shutdown (If Active)	0%	
Depth of Discharge Shutdown Delay (If Active)	0h 0m 0s	
Float Charge Timer	0h 0m 0s	
DC	DC Low Voltage Shutdown	Inactive/Active
	DC Low Voltage Shutdown (If Active)	0.0V
	DC Low Voltage Shutdown Delay (If Active)	0h 0m 0s
	DC Low Voltage Warning	Inactive/Active
	DC Low Voltage Warning (If Active)	0.0V
	DC Low Voltage Warning Return (If Active)	0.0V
	DC Low Voltage Warning Delay (If Active)	0h 0m 0s
	DC High Voltage Warning	Inactive / Active
	DC High Voltage Warning Return (If Active)	0.0V
	DC High Voltage Warning (If Active)	0.0V
	DC High Voltage Warning Delay (If Active)	0h 0m 0s
	DC High Voltage Shutdown (If Active)	0.0v
	DC High Voltage Shutdown Delay (If Active)	0h 0m 0s
	Delayed Over Current	Inactive/Active
	Delayed Over Current (If Active)	0A
	DC Battery Current Trip	Inactive/Active
	DC Battery Current Trip (If Active)	0A
	Load Current Trip	Inactive/Active
	Load Current Trip	0A
	Short Circuit Trip	Inactive / Active
	Short Circuit Trip	0A
	kW Overload Trip Warning	Inactive / Active
	kW Overload Trip Warning	0%
	kW Overload Trip Warning Return	0%
	kW Overload Trip Warning Delay	0h 0m 0s
	kW Overload Trip Shutdown	Inactive/Active
	kW Overload Trip Shutdown	0%
	kW Overload Trip Shutdown Delay	0h 0m 0s
	DC Shunt 1 Location (Setting unavailable if used in DC shunt 2)	Battery/Charge/Load
	DC Shunt 1 Voltage	0V
	DC Shunt 1 Amps	0A
	DC Shunt 2 location (Setting unavailable if used in DC shunt 1)	Battery/Charge/Load
DC Shunt 2 Voltage	0v	
DC Shunt 2 Amps	0A	



9.3 ACCESSING THE 'RUNNING' CONFIGURATION EDITOR

The 'running' editor can be entered while the engine is running. All protections remain active if the engine is running while the running editor is entered.

Press and hold the  button to enter the running editor.

9.3.1 EDITING A PARAMETER

Enter the editor as described above.

Press the  (left) or  (right) buttons to cycle to the section you wish to view/change.

Press the  (up or down) buttons to select the parameter you wish to view/change within the currently selected section.

To edit the parameter, press  to enter edit mode. The parameter begins to flash to indicate that you are editing the value.

Press the  (up or down) buttons to change the parameter to the required value.

Press  to save the value. The parameter ceases flashing to indicate that it has been saved.

To exit the editor at any time, press and hold the  button.

9.3.2 ADJUSTABLE PARAMETERS (RUNNING EDITOR)

Running Editor (Factory default settings are shown in bold italicised text)







Section	Parameter	Value
Display	Contrast	0%
	Language	English
Generator	AVR Tgt	0.00V

10 COMMISSIONING

Before the system is started, it is recommended that the following checks are made:-

- The unit is adequately cooled and all the wiring to the module is of a standard and rating compatible with the system. Check all mechanical parts are fitted correctly and that all electrical connections (including earths) are sound.
- The unit **DC** supply is fused and connected to the battery and that it is of the correct polarity.
- The Emergency Stop input is wired to an external **normally closed** switch connected to **DC positive**.

 **NOTE: If Emergency Stop feature is not required, link this input to the DC Positive. The module will not operate unless either the Emergency Stop is fitted correctly OR terminal 3 is connected to DC positive.**

- To check the start cycle operation, take appropriate measures to prevent the engine from starting (disable the operation of the fuel solenoid). After a visual inspection to ensure it is safe to proceed, connect the battery supply. Select  and then press  the unit start sequence will commence.
- The starter will engage and operate for the pre-set crank period. After the starter motor has attempted to start the engine for the pre-set number of attempts, the LCD will display 'Failed to start'. Select the  position to reset the unit.
- Restore the engine to operational status (reconnect the fuel solenoid). Select  and then press . This time the engine should start and the starter motor should disengage automatically. If not then check that the engine is fully operational (fuel available, etc.) and that the fuel solenoid is operating. The engine should now run up to operating speed. If not, and an alarm is present, check the alarm condition for validity, then check input wiring. The engine should continue to run for an indefinite period. It will be possible at this time to view the engine and alternator parameters - refer to the 'Description of Controls' section of this manual.
- Select  on the front panel, the engine will run for the pre-set cooling down period, then stop. The generator should stay in the standby mode. If not check that there is not a signal present on the **Remote start** input.
- Initiate an automatic start by supplying the remote start signal (if configured). The start sequence will commence and the engine will run up to operational speed. Once the generator is available a load transfer will take place (if configured), the Generator will accept the load. If not, check the wiring to the Generator Contactor Coil (*if used*). Check the Warming timer has timed out.
- Remove the remote start signal. The return sequence will begin. After the pre-set time, the generator is unloaded. The generator will then run for the pre-set cooling down period, then shutdown into its standby mode.
- Set the modules internal clock/calendar to ensure correct operation of the scheduler and event logging functions. For details of this procedure see section entitled *Front Panel Configuration – Editing the date and time*.
- If, despite repeated checking of the connections between the controller and the customer's system, satisfactory operation cannot be achieved, then the customer is requested to contact the factory for further advice on:-

11 FAULT FINDING

11.1 STARTING

Symptom	Possible Remedy
Unit is inoperative Read/Write configuration does not operate	Check the battery and wiring to the unit. Check the DC supply. Check the DC fuse.
Unit shuts down	Check DC supply voltage is not above 35 Volts or below 9 Volts Check the operating temperature is not above 70°C. Check the DC fuse.
Fail to Start is activated after pre-set number of attempts to start	Check wiring of fuel solenoid. Check fuel. Check battery supply. Check battery supply is present on the Fuel output of the module. Check the speed-sensing signal is present on the module's inputs. Refer to engine manual.
Continuous starting of generator when in  mode.	Check that there is no signal present on the "Remote Start" input. Check configured polarity is correct. Check the mains supply is available and within configured limits
Generator fails to start on receipt of Remote Start signal.	Check Start Delay timer has timed out. Check signal is on "Remote Start" input. Confirm correct configuration of input is configured to be used as "Remote Start". Check that the oil pressure switch or sensor is indicating low oil pressure to the controller. Depending upon configuration, then set will not start if oil pressure is not low.
Pre-heat inoperative	Check wiring to engine heater plugs. Check battery supply. Check battery supply is present on the Pre-heat output of module. Check pre-heat configuration is correct.
Starter motor inoperative	Check wiring to starter solenoid. Check battery supply. Check battery supply is present on the Starter output of module. Ensure that the Emergency Stop input is at Positive. Ensure oil pressure switch or sensor is indicating the "low oil pressure" state to the controller.

11.2 LOADING

Symptom	Possible Remedy
Engine runs but generator will not take load	Check Warm up timer has timed out. Ensure generator load inhibit signal is not present on the module inputs. Check connections to the switching device. Note that the set will not take load in manual mode unless there is an active remote start on load signal.
Incorrect reading on Engine gauges Fail to stop alarm when engine is at rest	Check engine is operating correctly. Check that sensor is compatible with the module and that the module configuration is suited to the sensor.

11.3 ALARMS

Symptom	Possible Remedy
Unit locks out on Emergency Stop	If no Emergency Stop Switch is fitted, ensure that a DC positive signal is connected to the Emergency Stop input. Check emergency stop switch is functioning correctly. Check Wiring is not open circuit.
Intermittent Magnetic Pick-up sensor fault	Ensure that Magnetic pick-up screen only connects to earth at one end, if connected at both ends, this enables the screen to act as an aerial and will pick up random voltages. Check pickup is correct distance from the flywheel teeth.
Low oil Pressure fault operates after engine has fired	Check engine oil pressure. Check oil pressure switch/sensor and wiring. Check configured polarity (if applicable) is correct (i.e. Normally Open or Normally Closed) or that sensor is compatible with the module and is correctly configured.
High engine temperature fault operates after engine has fired.	Check engine temperature. Check switch/sensor and wiring. Check configured polarity (if applicable) is correct (i.e. Normally Open or Normally Closed) or that sensor is compatible with the module.
Shutdown fault operates	Check relevant switch and wiring of fault indicated on LCD display. Check configuration of input.
Warning fault operates	Check relevant switch and wiring of fault indicated on LCD display. Check configuration of input.
CAN ECU WARNING CAN ECU SHUTDOWN	This indicates a fault condition detected by the engine ECU and transmitted to the DSE controller. Press the RIGHT ARROW button to view the engine diagnostic code and consult the engine manufacturer's documentation.
CAN DATA FAIL	Indicates failure of the CAN data link to the engine ECU. Check all wiring and termination resistors (if required). Check the ECU OVERRIDE function detailed in the section entitled OPERATION elsewhere in this manual.
Incorrect reading on Engine gauges	Check engine is operating correctly. Check sensor and wiring paying particular attention to the wiring to terminal 47 (refer to appendix). Check that sensor is compatible with the module and that the module configuration is suited to the sensor.
Fail to stop alarm when engine is at rest	

11.4 COMMUNICATIONS

Symptom	Possible Remedy
CAN DATA FAIL	Indicates failure of the CAN data link to the engine ECU. Check all wiring and termination resistors (if required). Check the ECU OVERRIDE function detailed in the section entitled OPERATION elsewhere in this manual.
RS485 inoperative	Check : <ul style="list-style-type: none"> • Connection cable – Belden 9841 or equivalent • 120Ω termination resistors are correctly fitted • Baud rate of controller and of master device are the same • Slave ID of the controller is the same as configured in the master device
RS232 connection to PC inoperative	Check : <ul style="list-style-type: none"> • RS232 maximum of 15m is not exceeded • Direct to PC connection requires a Crossover (NULL modem) RS232 cable • Baud rate of controller and of master device are the same • Slave ID of the controller is the same as configured in the master device
RS232 connection to GSM modem inoperative	Check : <ul style="list-style-type: none"> • RS232 maximum of 15m is not exceeded • Modem Initialisation strings in the DSE configuration is correct for the connected modem type • Modem is configured to 9600 baud • SIM card is CSD (circuit switched data) compatible • SIM card is not PIN locked • SIM card is correctly inserted • Antenna is correctly installed and is not inside an earthed metal cabinet / control panel • A good signal is available in the locality
RS232 connection to landline modem inoperative	Check : <ul style="list-style-type: none"> • RS232 maximum of 15m is not exceeded • Modem Initialisation strings in the DSE configuration is correct for the connected modem type • Modem is configured to 9600 baud
Ethernet comms direct to PC inoperative	Check : <ul style="list-style-type: none"> • Ethernet rated cable is used • Direct to PC connection requires a CROSSOVER cable. • Check the IP address of the DSE controller is correct • Check the PC is not set to <i>obtain IP address automatically</i> • Check PC firewall will allow traffic on the configured port.
Ethernet connected to a router.	Check : <ul style="list-style-type: none"> • Ethernet rated cable is used • Router connection requires a <i>straight through</i> cable. • Check the IP address of the DSE controller is correct • Check all firewalls and routers will allow traffic on the configured port. • Test the controller connected directly to a PC for test purposes to eliminate router problems.

11.5 INSTRUMENTS

Symptom	Possible Remedy
Inaccurate generator measurements on controller display	<p>Check that the shunt settings are correct for the application.</p> <p>Check that the shunts are wired correctly with regards to the direction of current flow and additionally ensure that shunts are connected in the correct.</p> <p>The controller is true RMS measuring so gives more accurate display when compared with an 'averaging' meter such as an analogue panel meter or some lower specified digital multimeters.</p> <p>Accuracy of the controller is better than 1% of full scale. Ie Gen volts full scale is 150V ph-n so accuracy is $\pm 1.5V$ (1% of 150V).</p>

11.6 MISCELLANEOUS

Symptom	Possible Remedy
Module appears to 'revert' to an earlier configuration	<p>When editing a configuration using the PC software it is vital that the configuration is first 'read' from the controller before editing it. This edited configuration must then be "written" back to the controller for the changes to take effect.</p> <p>When editing a configuration using the fascia editor, be sure to press the Accept  button to save the change before moving to another item or exiting the fascia editor</p>







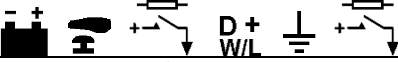
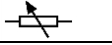

 **NOTE: The above fault finding is provided as a guide check-list only. As the module can be configured to provide a wide range of different features, always refer to the source of your module configuration if in doubt.**

12 MAINTENANCE, SPARES, REPAIR AND SERVICING

The controller is *Fit and Forget*. As such, there are no user serviceable parts within the controller. In the case of malfunction, you should contact your original equipment manufacturer (OEM).

12.1 PURCHASING ADDITIONAL CONNECTOR PLUGS FROM DSE

If you require additional plugs from DSE, please contact our Sales department using the part numbers below.

Module Terminal Designation	Plug Description	Part No.
1-13 	13 way 5.08mm	007-166
15-19 	5 way 5.08mm	007-445
22-38  CAN ↑↓ MSC GOV AVR	17 way 5.08mm	007-452
39-46  V1	8 way 7.62mm	007-454
47-50  V2	4 way 7.62mm	007-171
51-57 	8 way 5.08mm	007-164
60-70 	10 way 5.08mm	007-451
 RS485	3 way 5.08mm	007-174
 USB	PC Configuration interface lead (USB type A – USB type B)	016-125

 **NOTE:** Terminals 20 & 21 are not fitted.

12.2 PURCHASING ADDITIONAL FIXING CLIPS FROM DSE

Item	Description	Part No.
	Module fixing clips (packet of 4)	020-294







12.3 PURCHASING ADDITIONAL SEALING GASKET FROM DSE

Item	Description	Part No.
	Module silicon sealing gasket	020-507

12.4 DSENET EXPANSION MODULES

NOTE: A maximum of twenty (20) expansion modules can be connected to the DSENet®.

NOTE: DSENet® utilises an RS485 connection. Using Belden 9841 (or equivalent) cable allows for the expansion cable to be extended to a maximum of 1.2km. DSE Stock and supply Belden 9841 cable. DSE Part Number 016-030.

Item	Max No. supported	Description	DSE Part Numbers			
			Model order number	Sales literature	Operator manual	Installation Instructions
	4	Model DSE2130 input module provides additional analogue and digital inputs for use with the controller.	2130-001-00	055-060	057-082	053-033
	4	Model DSE2131 Ratio-metric input expansion module provides additional resistive, digital, 0-10V and 4-20ma inputs for use with the controller.	2131-001-00	055-115	057-139	053-125
	4	Model DSE2133 RTD/Thermocouple input expansion module provides additional RTD and thermocouple inputs for use with the controller.	2133-001-00	055-114	057-140	053-126
	4	Model DSE2152 Ratio-metric output expansion module provides additional 0-10V and 4-20ma outputs for use with the controller.	2152-001-00	055-112	057-141	053-134
	10	Model DSE2157 expansion relay module provides eight additional voltage free relays for use with the controller	2157-001-00	055-061	057-083	053-034
	10	Model DSE2548 expansion LED module provides additional LED indications, internal sounder and remote lamp test/alarm mute for use with the controller.	2548-001-00	055-062	057-084	053-032

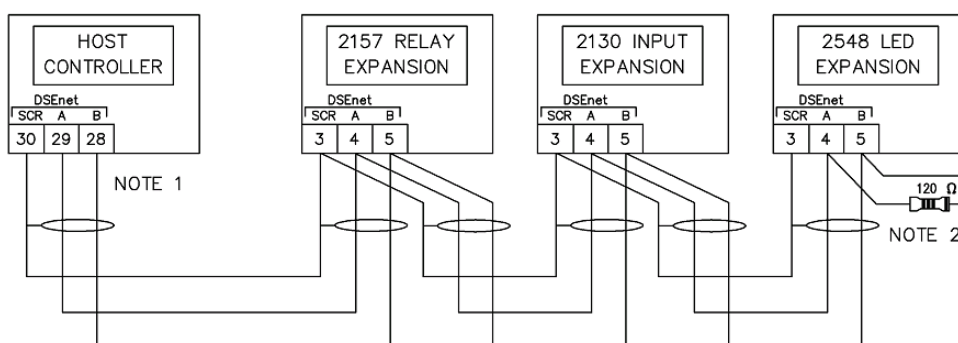

NOTE 1
AS A TERMINATING RESISTOR IS INTERNALLY FITTED TO THE HOST CONTROLLER, THE HOST CONTROLLER MUST BE THE FIRST UNIT ON THE DSEnet

NOTE 2
A 120 OHM TERMINATION RESISTOR MUST BE FITTED TO THE LAST UNIT ON THE DSEnet

13 WARRANTY

DSE Provides limited warranty to the equipment purchaser at the point of sale. For full details of any applicable warranty, refer to the original equipment supplier (OEM)

14 DISPOSAL

14.1 WEEE (WASTE ELECTRICAL AND ELECTRONIC EQUIPMENT)

If you use electrical and electronic equipment you must store, collect, treat, recycle and dispose of WEEE separately from your other waste



This Page is Intentionally Left Blank